

MITSUBISHI

GK11F

A COMPLETELY BALANCED DRILLING SYSTEM FOR OVERBURDEN DRILLING

SUPER MAXBIT

The SUPER MAXBIT gives stability when drilling collapsing overburden formations.



MITSUBISHI MATERIALS

SUPER MAXBIT

The SUPER MAXBIT gives stability when drilling collapsing overburden formations.

This is an advanced technology compared to the other eccentric drilling methods. It consists of two to three wings connected to the Down The Hole Hammer. The bit head are extendable/retractable when the drill string rotates in the forward/reverse direction. Drilling and casing are possible simultaneously with the use of a casing shoe.

The SUPER MAXBIT has a following advantages:

- High-speed drilling similar to a standard DTH bit.
- Straight hole drilling.
- Uniform rotation while drilling of boulders, sand and gravel.
- Reliability of extending and retracting proven by customer experiences.

MECHANISM

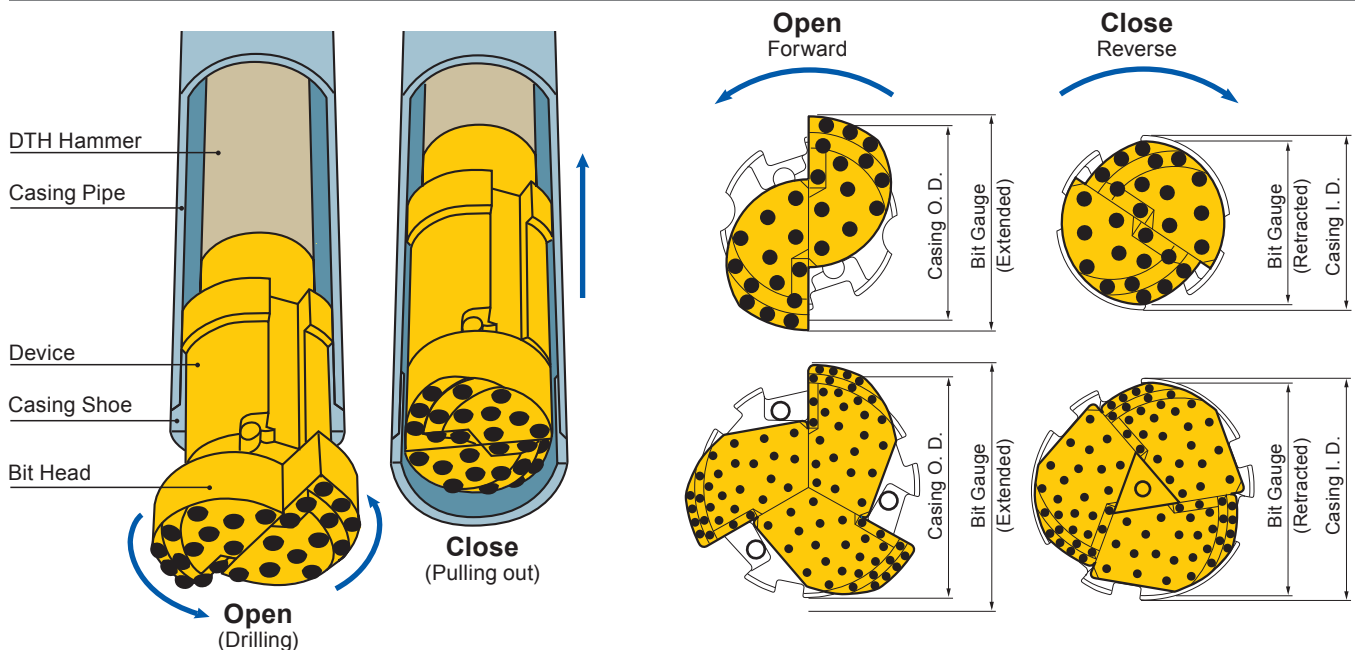

COMPONENTS

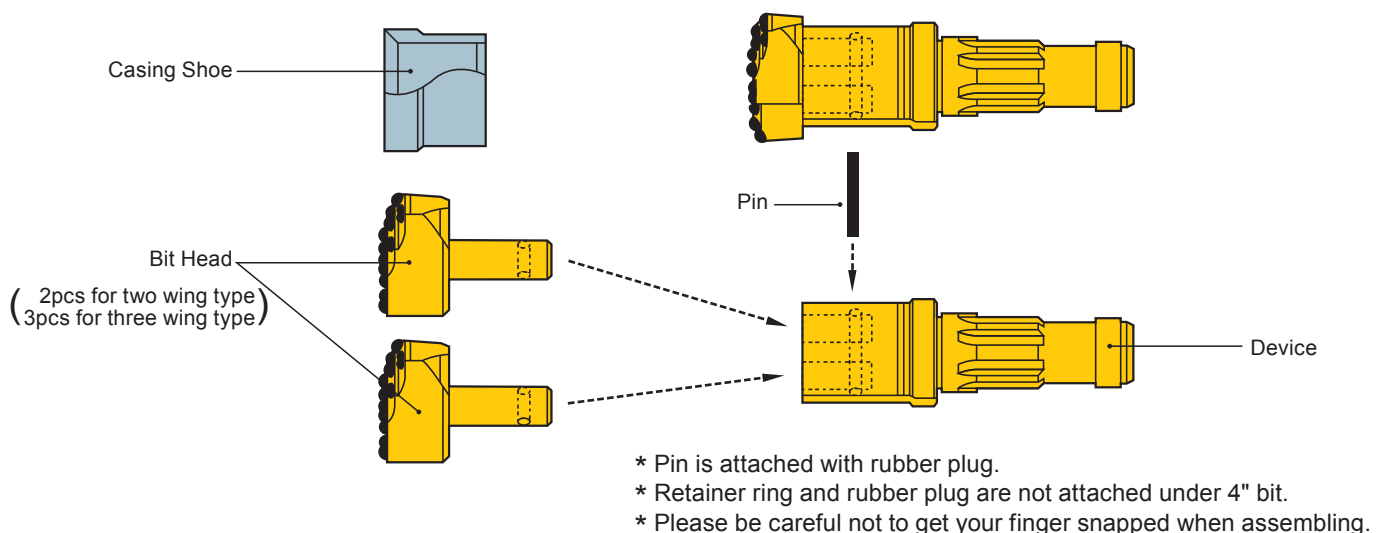

OTHERS

Rotation Speed of Bit

Target external rotation speed to 15-20m/min.
Refer to the following figure for rotation.
Select the range of uniform rotation during drilling.

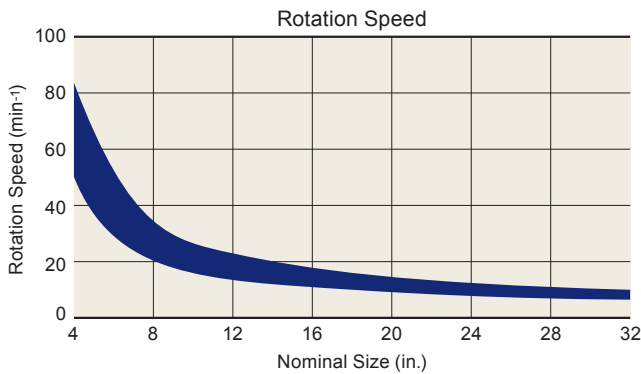

Setting Compressor

- Pressure
 - Set between 0.7 to 1.0MPa (100-150psi)
 - Consider the depth of underground water when drilling through the layer.
(In case of 30m (90ft) depth, add 0.3MPa (45psi) to the air pressure.)
 - Do not set over 1.5MPa (225psi)

- Air Consumption
 - Set the air supply using the following formula.

$$Q = \frac{V(D^2 - d^2)}{1273500}$$

- Q : Air supply (m³/min)
- D : Inside diameter of casing (mm)
- d : Outside diameter of jacket or hammer (mm)
- V : Air speed 1,100-1,500 (m/min)

Recommended Air Consumption

Nominal Size (in.)	Air Supply	
	(m³/min)	(cfm)
4	4-15	140-530
8	19-26	670-920
12	33-45	1,170-1,590
16	42-57	1,480-2,010
20	59-80	2,080-2,830
24	72-98	2,540-3,460
28	81-111	2,860-3,920
32	90-122	3,180-4,310

Exchange of components is necessary

- Wings
 1. When the wear detection mark on a wing disappears.
 2. When the carbide wear is excessive.
 3. When wing body wears and carbides pop out.



- Device
 - When the wear detection marks on the device end disappear.

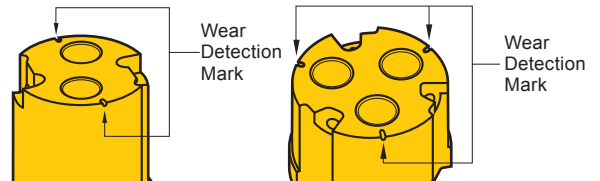

- Pin
 - When the wear attains the following value.
 - Please exchange the pin if you observe excessive wear.

	Two Wing Type	Three Wing Type
Amount of Wear (mm)	0.5-1.0	0.5-1.0
Geometry		

APPLICATIONS

The SUPER MAXBIT is designed for drilling in gravel, clay, sand mixture, boulders and easy collapsing overburden. The system is applicable for the various intentions with the combination of appropriate rig and drill.



Water Well
Drilling water wells down to 50-250m in depth.



Piling
After casing through the collapsing overburden, insert a H-steel, then pull up the casing.



Foundation
Foundational construction of buildings and bridges up to 32"(ø800) of casing diameter.



Pipe Roof, Water Service Water Remove, Anchoring
It achieves excellent results for drilling of long holes and hard formations using the Down The Hole Hammer. Top-Hammer applications are available.



Geothermal, Oil Well
Surface drilling down to 50m in depth for geothermal and oil well.

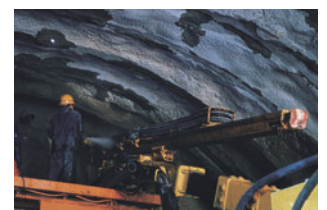

Fore Piling
For piling as a reinforced method of tunneling in collapsing overburden.

TROUBLE SHOOTING

Trouble	Reason	Solution
Less hammering.	Air pressure is too low to work. (The hole is too deep that causes shortage of air pressure)	Compressor should be replaced with a bigger one, or install one more compressor and air receiver tank.
	Just drilling through clay formation. Drive sub is loosen.(in the thread)	The frequent hole cleaning is necessary. Rotate in forward direction may screw down. Pull up casing pipe and screw down, the drill strings with the driver sub properly.
	Sand or clay infiltrating into the hammer. Cutting are remaining between driver sub and bit wing.	Wipe off sand or clay inside the hammer. Flushing out cuttings enough.
	Cutting are sticking in bit blow hole.	Flushing frequently.
The bit does not rotate at all.	Drilling through fractured zone.	The bit should be operated with lower feed pressure.
	Hit a scrap iron.	Pull up the drill strings, and remove a scrap iron by casing a rotary bit. After that,start drilling with SUPER MAXBIT.
	The bottom of the hole is filled with cuttings.	Water inside the casing pipe, and cuttings should be flushed out easily.
	Machine torque is too low.	Machine should be replaced with a bigger one.
	Sticking through cave zone.	Pull up the drill strings and casing pipe about 20-30cm, then screw down slowly with hammering.
Cutting are not flushed out of the hole well.	Less air compressor or air volume.	Compressor should be replaced with a bigger one or install one more compressor and air receiver tank.
	Just drillings through clay formation.	The frequent hole cleaning is necessary.
	Cutting are staying inside the casing pipe.	Water inside the casing pipe and cutting should be flushed out easily.
	Drilling through cracky formation that leaks out air so much.	Water inside the casing pipe and cutting should be flushed out easily.
	Air leaking from slited casing pipe.	Before drilling, plugging up the slit of casing pipe by using tape.
Casing pipes are not driven down.	Breakage of the weld joint.	Weld carefully so that the weld on the inside of the casing pipe. Check the casing pipe is vertical and is linear. Check that each weld is straigh and smooth so that the friction between the casing pipe and hole wall is minimam.
	Breakage of the thread joint.	Never use threaded joint casing pipe in deep hole. (more than 20m)
Breakage of the pin.	Knocking on the side pin by hammering while the bit is not on the bottom.	Keep the bit wings on the bottom of the hole.
	Hammering in sand formation.	Feed and air pressure must be carefully watched to keep the face at the bit wing.
The bit wings does not open.	The bit wings is not on the bottom of the hole.	Keep the bit wings on the bottom with higher feed pressure.
	Clay or mud has instruded into the hole of the device.	Clean the holes of the device.
	Ground condition is too sticky to open.	Pull up the bit, (you should throw some small gravel.) and put small amount of gravel into the hole to get some friction which is needed for extension.
The bit wings does not close.	The bit wings is not on the bottom of the hole.	Keep the bit wings on the bottom with higher feed pressure.
	Cutting are sticking around the bit wings so much.	Flushing out cutting enough.
The drill strings can not be pulled out.	The thickness of the weld inside of the casing pipes exceeds limitation. (>0.5mm=1/64")	Pull up the drill strings slowly with forward slow rotation carefully. Please do not hurry to pull up, because the overweld of casing tubes can be ground off by the device shoulder. So it may take a long time to do so. 
	There is a concave on the outside of the casing pipes which has broken during drilling.	In water well drilling, sometimes rock or gravel will be pushed into slots of straner that will cause a concave on the casing pipes. So carefull operations are necessary. 

APPROPRIATE CASING AND HAMMER SIZE

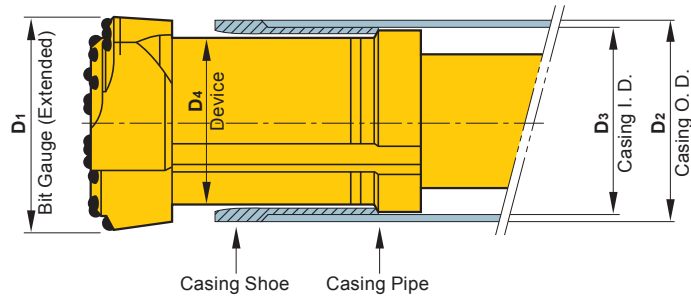

Type	Two Wing	Three Wing	Bit Gauge				Applicable Casing Pipe			Device O. D. D ₄	Hammer Size	* 1	* 2	* 3	* 4	* 5
			Extended D ₁		Retracted		Max. O.D. D ₂	Min. I.D. D ₃	Nominal Size							
			mm	in.	mm	in.	mm	mm	in.							
90	●		125	4.92	91	3.58	114.3	102.3	4"	92	3"					
115	●		152	5.98	114	4.49	141.3	126.6	5"	115	4"					
140	●		185	7.28	140	5.51	165.2	153.2	6"	141	5"					
165	●		215	8.46	166	6.54	190.7	178.7	7"	167	6"					
187	●		237	9.33	186	7.32	216.3	202.3	8"	187	6"					
215	●	●	272	10.71	217	8.54	254.0	241.0	9"	218	8"					
240		●	290	11.42	232	9.13	273.1	254.5	10"	240	8"					
280		●	340	13.39	281	11.06	318.5	301.7	12"	283	10"					
315		●	373	14.69	314	12.36	355.6	336.6	14"	316	12"					
365		●	425	16.73	363	14.29	406.4	387.4	16"	365	12"					
410		●	478	18.82	412	16.22	457.2	435.0	18"	414	15"					
460		●	530	20.87	461	18.15	508.0	482.6	20"	463	15" 18"					
510		●	580	22.83	509	20.04	558.8	533.4	22"	511	15" 18"					
560		●	630	24.80	559	22.01	609.6	584.2	24"	561	18"					
600		●	685	26.97	600	23.62	660.4	631.8	26"	603	20"					

* When ordering, information about casing diameters (O.D. and I.D.) is necessary.
* Order made bits can be manufactured upon request.

*1 : Water Well
*2 : Piling, Foundation
*3 : Pipe Roof, Water Service, Water Remove, Anchoring
*4 : Geothermal, Oil Well
*5 : Fore Piling

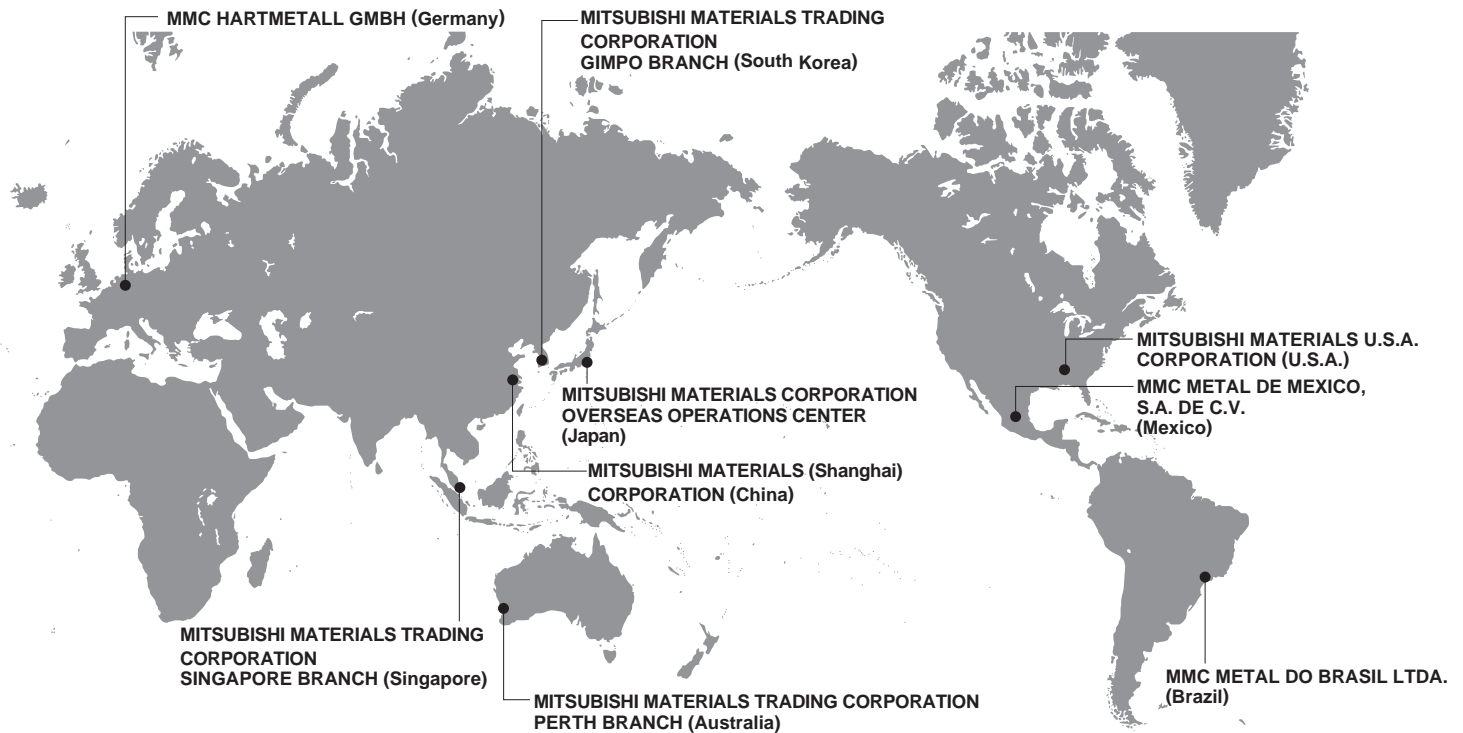

MITSUBISHI MATERIALS CORPORATION

JAPAN / ROCK TOOLS

**MITSUBISHI MATERIALS CORPORATION
OVERSEAS OPERATIONS CENTER**

KFC bldg., 7F, 1-6-1, Yokoami, Sumida-ku, Tokyo 130-0015, Japan
TEL +81-3-5819-8723 FAX +81-3-5819-5259

E-Mail: rocktool@mmc.co.jp

Subsidiaries of MITSUBISHI MATERIALS CORPORATION

U.S.A.	MITSUBISHI MATERIALS U.S.A. CORPORATION Rock Tools Office 2690 Salisbury Highway, Statesville, NC 28677, U.S.A. TEL +1-800-423-1358 FAX +1-888-834-2248 E-Mail: mmusclt@mmus.com	Australia	MITSUBISHI MATERIALS TRADING CORPORATION Unit1, 58 Catalano Circuit Canning Vale, WA 6155 Australia TEL +61-8-6258-7200 FAX +61-8-6258-5614 E-Mail: admin@mmtau.com
Germany	MMC HARTMETALL GMBH Comeniusstr. 2,40670 Meerbusch, Germany TEL +49-2159-9189-32 FAX +49-2159-9189-30079 E-Mail: rocktools@mmchg.de	South Korea	MITSUBISHI MATERIALS TRADING CORPORATION 761, Jiwol-Ri, Pattan-Myeon, Hwaseong-Si, Gyeonggi-Do, 445-917 Korea TEL +82-31-8059-1895 FAX +82-31-8059-1897
Brazil	MMC METAL DO BRASIL LTDA. Rua Cincinato Braga, 340 13º andar. Bela Vista- CEP 01333-010 São Paulo-SP., BRASIL TEL +55-11-3262-5095 FAX +55-11-3285-4906 E-Mail: mubr@mubr.com.br	Singapore	MITSUBISHI MATERIALS TRADING CORPORATION 10 Anson Road, #32-09 International Plaza, 079903 Singapore TEL +65-6221-7233 FAX +65-6325-4220
Mexico	MMC METAL DE MEXICO S.A. DE C.V. Av. La Canada No.16 Parque Industrial Bernardo Quintana El marques, Queretaro. TEL +52-442-221-6136 +52-442-221-6137 FAX +52-442-221-6134 E-Mail: gonzalez@mmcmex.com	China	MITSUBISHI MATERIALS (Shanghai) CORPORATION Room 3911, UNITED PLAZA 1468, Nanjing Road West, Shanghai, 200040 China TEL +86-21-6235-0745 FAX +86-21-6235-0741

<http://mrt.mitsubishicarbide.com>

