

SCREW-IN TOOLS

**Easy to use screw-in heads
for mould and die machining.**









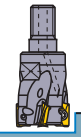

- Interchangeable heads from all main types of Mitsubishi Materials milling tools.
- Standard series includes steel, straight shank and high rigidity carbide types.
- BT and HSK shank arbors available in ultra compact size.

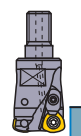

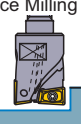
SCREW-IN TOOLS

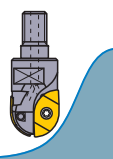
Features

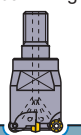
Screw-in tools can be used for a wide variety of machining applications.

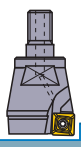
Screw-in Head			Screw-in Arbor	
Product Name	Application	Features		
APX3000/4000  <p>Ⓟ P.3</p>	<ul style="list-style-type: none"> ● Shoulder Milling ● Copy Milling ● Face Milling 	<ul style="list-style-type: none"> ● 11°, 15° positive, low cutting force insert. ● High accuracy, high quality vertical wall. ● With through coolant holes. 	<ul style="list-style-type: none"> ● Straight Shank Arbor <p>Steel shank type : General machining Carbide shank type : High rigidity applications</p> 	
AJX  <p>Ⓟ P.4</p>	<ul style="list-style-type: none"> ● Pocket Milling ● Face Milling 	<ul style="list-style-type: none"> ● High rigidity double clamp structure. ● Suitable for high feed cutting. ● 13°, 15° positive insert. ● Special insert design with 3 cutting edges. ● With through coolant holes. 	<ul style="list-style-type: none"> ● BT30/40 Shank Arbor <p>Integral tool for a shorter overhang!</p> 	
AQX  <p>Ⓟ P.5</p>	<ul style="list-style-type: none"> ● Pocket Milling ● Copy Milling ● Drilling ● Shoulder Milling ● Face Milling 	<ul style="list-style-type: none"> ● The centre bottom cutting edge enables drilling without previously formed hole. ● High rigidity body design. ● With through coolant holes. 	<ul style="list-style-type: none"> ● HSK63A Shank Arbor <p>Effective when used on high speed, low rigidity machining centres!</p> 	
SRM2  <p>Ⓟ P.6</p>	<ul style="list-style-type: none"> ● Curved Face Milling ● Copy Milling ● Contour Milling 	<ul style="list-style-type: none"> ● Suitable for roughing to semi-finishing of small and medium moulds. ● Low resistance chipbreaker. ● High rigidity body design. ● With through coolant holes. 		
ARX  <p>Ⓟ P.7</p>	<ul style="list-style-type: none"> ● Slot Milling ● Corner Radius Milling ● Copy Milling ● Face Milling 	<ul style="list-style-type: none"> ● 15° positive, high tolerance M-class insert. ● Effective for various machining applications. ● With through coolant holes. 		
ASX400  <p>Ⓟ P.8</p>	<ul style="list-style-type: none"> ● Shoulder Milling ● Face Milling 	<ul style="list-style-type: none"> ● Precise but inexpensive moulded type 20° positive inserts. ● Economical 4 cutting edge inserts. ● Curved cutting edge and high rigidity holder. ● With through coolant holes. 		

Cutting Performance

Carbide Shank Arbor

● Possible to machine with overhangs of up to 6xD (standard type: 2xD)

<Screw-in Tool>

Carbide Arbor : SC32M16S280LW
Screw-in Head : AJX12R322AM1645

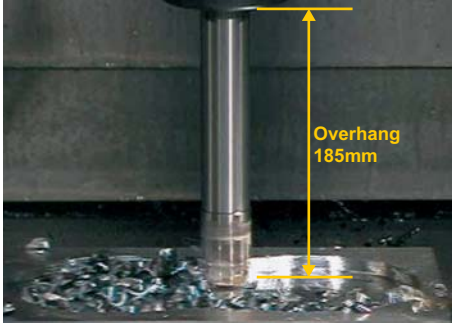

<Standard Arbor>

Arbor : BT50 milling chuck
Holder : AJX12R322SA32S

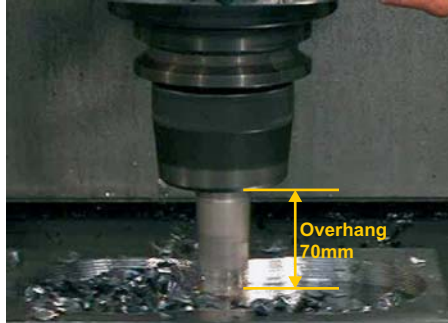

<Cutting Conditions>

Workpiece : JIS SCM440
Insert : JDMW12420ZDSR-FT (VP15TF)
Cutting speed: 150m/min
Feed rate : 4,000mm/min
Feed per tooth: 1.33–2.4mm/tooth
Depth of cut : 2.0mm (Axial)
32mm (Radial)

Dry cutting

* The overhang length differs depending the tool and cutting conditions.

BT Shank Arbor

● Compact size enables high quality machining!

<Screw-in Tool>

BT Arbor : SC20M10S10-BT30
Screw-in Head : APX3000R203M10A30

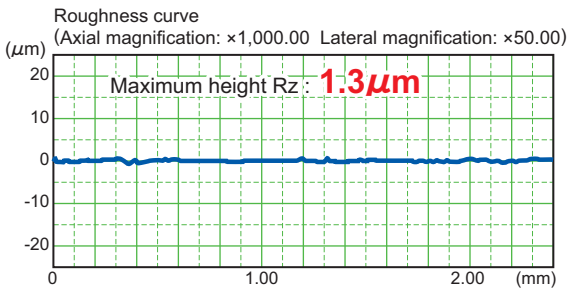
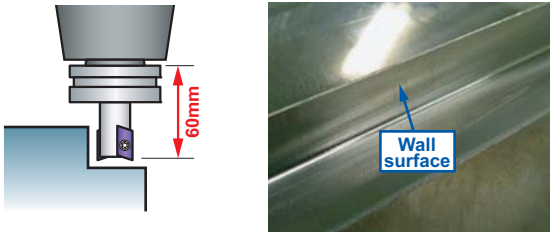

<Standard Arbor>

Arbor : BT30 milling chuck
Holder : APX3000R203SA20SA

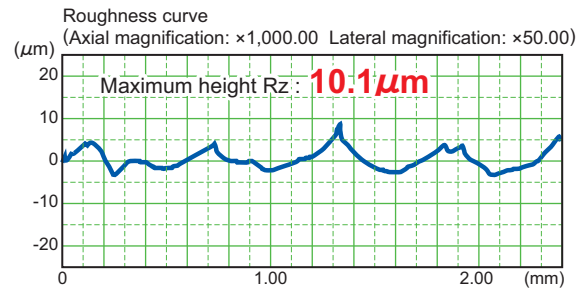
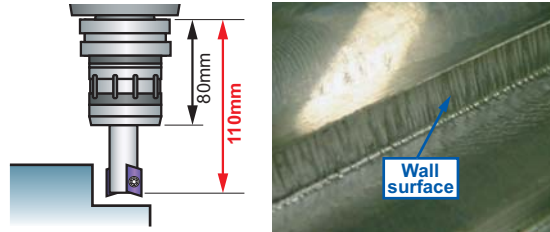

<Cutting Conditions>

Workpiece : JIS S55C
Insert : AOMT123608PEER-M (VP15TF)
Cutting speed : 160m/min

Feed rate : 764mm/min
Feed per tooth : 0.1mm/tooth

Depth of cut: 6.0mm (Axial)
10.0mm (Radial)
Dry cutting

● A wide application range

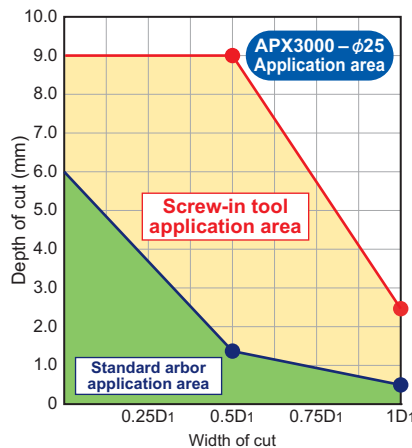
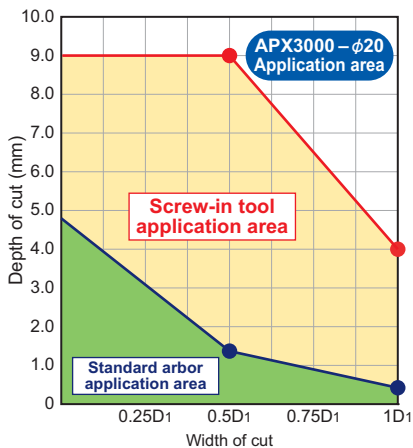

<Cutting Conditions>



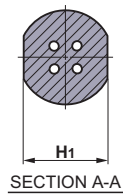
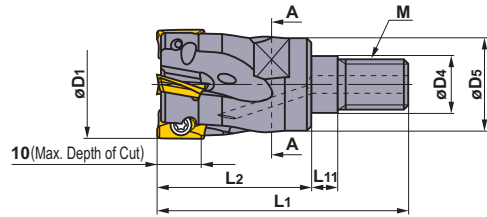
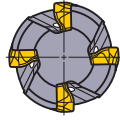

Workpiece : JIS S55C
Cutting speed : 160m/min
Feed per tooth : 0.1mm/tooth
Dry cutting
D1 : Cutting edge diameter

SCREW-IN TOOLS

APX3000

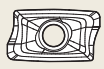

Right hand tool only.



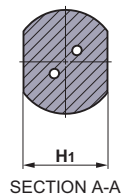
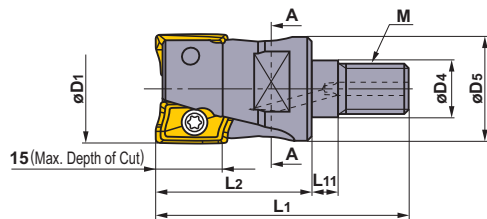
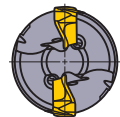

Order Number	Stock		Number of Teeth	Dimensions (mm)								Mass (kg)				
	R	Coolant Hole		D1	D4	D5	L1	L2	L11	H1	M					
APX3000R162M08A30	●	○	2	16	8.5	13	48	30	6	10	M8	0.1	TPS25	TIP07F	MK1KS	AOMT1236 
182M08A30	●	○	2	18	8.5	13	48	30	6	10	M8	0.1	TPS25	TIP07F	MK1KS	
203M10A30	●	○	3	20	10.5	18	49	30	6	14	M10	0.1	TPS25	TIP07F	MK1KS	
223M10A30	●	○	3	22	10.5	18	49	30	6	14	M10	0.1	TPS25	TIP07F	MK1KS	
254M12A35	●	○	4	25	12.5	21	57	35	6	19	M12	0.2	TPS25-1	TIP07F	MK1KS	
284M12A35	●	○	4	28	12.5	21	57	35	6	19	M12	0.2	TPS25-1	TIP07F	MK1KS	
304M16A40	●	○	4	30	17	29	63	40	6	24	M16	0.3	TPS25-1	TIP07F	MK1KS	
325M16A40	●	○	5	32	17	29	63	40	6	24	M16	0.3	TPS25-1	TIP07F	MK1KS	
355M16A40	●	○	5	35	17	29	63	40	6	24	M16	0.3	TPS25-1	TIP07F	MK1KS	
406M16A40	●	○	6	40	17	29	63	40	6	24	M16	0.3	TPS25-1	TIP07F	MK1KS	

Note) For the recommended cutting conditions, refer to pages C086 - C089 in C003J general catalogue or B055G Tools News.

APX4000

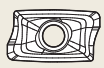

Right hand tool only.

Order Number	Stock		Number of Teeth	Dimensions (mm)								Mass (kg)				
	R	Coolant Hole		D1	D4	D5	L1	L2	L11	H1	M					
APX4000R252M12A35	●	○	2	25	12.5	23.5	57	35	6	19	M12	0.2	TPS4	TIP15W	MK1KS	AOMT1848 
282M12A35	●	○	2	28	12.5	23.5	57	35	6	19	M12	0.2	TPS4	TIP15W	MK1KS	
322M16A40	●	○	2	32	17	28.5	63	40	6	24	M16	0.3	TPS4	TIP15W	MK1KS	
323M16A40	●	○	3	32	17	28.5	63	40	6	24	M16	0.3	TPS4	TIP15W	MK1KS	
352M16A40	●	○	2	35	17	28.5	63	40	6	24	M16	0.3	TPS4	TIP15W	MK1KS	
353M16A40	●	○	3	35	17	28.5	63	40	6	24	M16	0.3	TPS4	TIP15W	MK1KS	
403M16A40	●	○	3	40	17	28.5	63	40	6	24	M16	0.3	TPS43	TIP15W	MK1KS	
404M16A40	●	○	4	40	17	28.5	63	40	6	24	M16	0.3	TPS43	TIP15W	MK1KS	

Note) For the recommended cutting conditions, refer to pages C090 - C093 in C003J general catalogue or B055G Tools News.

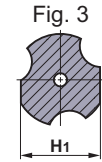
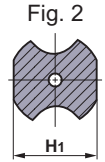
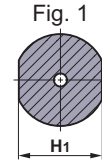
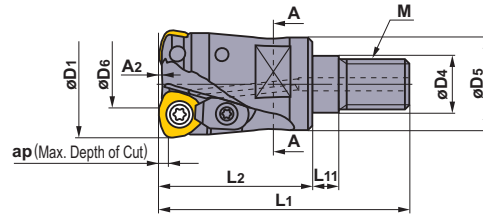

SECTION A-A

Right hand tool only.

Order Number	Stock	Coolant Hole	Number of Teeth	Dimensions (mm)											Mass (kg)	Figure	Clamp Screw	Clamp Bridge	Clamp Bridge Screw	Spring	Wrench	Insert
				D1	D4	D5	D6	L1	L2	L11	H1	M	ap	A2								
AJX06R162AM0830	●	○	2	16	8.5	13	8.9	48	30	6	10	M8	1.0	0.3	0.1	1	TS25	—	—	—	①TKY08F	JOM 06 T215ZZSR
172AM0830	●	○	2	17	8.5	13	9.9	48	30	6	10	M8	1.0	0.3	0.1	1	TS25	—	—	—	①TKY08F	
203AM1030	●	○	3	20	10.5	18	12.9	49	30	6	14	M10	1.0	0.3	0.1	3	TS25	—	—	—	①TKY08F	
223AM1030	●	○	3	22	10.5	18	14.9	49	30	6	14	M10	1.0	0.3	0.1	3	TS25	—	—	—	①TKY08F	
AJX08R202AM1030	●	○	2	20	10.5	18	11.4	49	30	6	14	M10	1.5	0.5	0.1	2	TS33	—	—	—	①TKY08D	JOM 080 320ZZSR
222AM1030	●	○	2	22	10.5	18	13.4	49	30	6	14	M10	1.5	0.5	0.1	2	TS33	—	—	—	①TKY08D	
253AM1235	●	○	3	25	12.5	21	16.4	57	35	6	19	M12	1.5	0.5	0.1	1	TS33	—	—	—	①TKY08D	
283AM1235	●	○	3	28	12.5	21	19.4	57	35	6	19	M12	1.5	0.5	0.1	1	TS33	—	—	—	①TKY08D	
AJX09R252AM1235	●	○	2	25	12.5	21	14.9	57	35	6	19	M12	2.0	1.0	0.2	2	TS351	AMS3	AJS3010T10	ASS2	②TKY10D	JDM 09T 320ZDSR
282AM1235	●	○	2	28	12.5	21	17.9	57	35	6	19	M12	2.0	1.0	0.2	2	TS351	AMS3	AJS3010T10	ASS2	②TKY10D	
303AM1645	●	○	3	30	17	29	20.0	68	45	6	24	M16	2.0	1.0	0.2	1	TS351	AMS3	AJS3010T10	ASS2	②TKY10D	
323AM1645	●	○	3	32	17	29	21.9	68	45	6	24	M16	2.0	1.0	0.2	1	TS351	AMS3	AJS3010T10	ASS2	②TKY10D	
353AM1645	●	○	3	35	17	29	24.9	68	45	6	24	M16	2.0	1.0	0.2	1	TS351	AMS3	AJS3010T10	ASS2	②TKY10D	
404AM1645	●	○	4	40	17	29	29.9	68	45	6	24	M16	2.0	1.0	0.2	1	TS351	AMS3	AJS3010T10	ASS2	②TKY10D	
AJX12R302AM1645	●	○	2	30	17	29	18.3	68	45	6	24	M16	2.0	1.5	0.3	2	TS407	AMS4	AJS4012T15	ASS2	②TKY15D	JDM 120420 ZDSR
322AM1645	●	○	2	32	17	29	20.3	68	45	6	24	M16	2.0	1.5	0.3	2	TS43	AMS4	AJS4012T15	ASS2	②TKY15D	
352AM1645	●	○	2	35	17	29	23.3	68	45	6	24	M16	2.0	1.5	0.3	2	TS43	AMS4	AJS4012T15	ASS2	②TKY15D	
403AM1645	●	○	3	40	17	29	28.3	68	45	6	24	M16	2.0	1.5	0.3	2	TS43	AMS4	AJS4012T15	ASS2	②TKY15D	

Note) For the recommended cutting conditions, refer to pages C118 - C121 in C003J general catalogue or B028G Tools News.

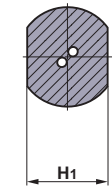
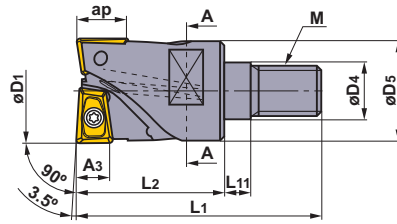
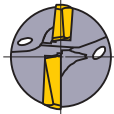

SCREW-IN TOOLS

AQX



SECTION A-A

Right hand tool only.

Order Number	Stock	Coolant Hole	Dimensions (mm)										Mass (kg)			
			D1	D4	D5	L1	L2	L11	H1	M	A3 ^{*1}	ap ^{*2}				
AQXR162M08A30	●	○	16	8.5	14.7	48	30	6	10	M8	4.5	7.4	0.1	TS2A	①TKY06F	QO·T0830R-○○
172M08A30	●	○	17	8.5	14.5	48	30	6	10	M8	4.5	7.4	0.1	TS2A	①TKY06F	QO·T0830R-○○
202M10A30	●	○	20	10.5	18.6	49	30	6	14	M10	6	9.2	0.2	TS25	①TKY08F	QO·T1035R-○○
212M10A30	●	○	21	10.5	18.5	49	30	6	14	M10	6	9.2	0.2	TS25	①TKY08F	QO·T1035R-○○
252M12A35	●	○	25	12.5	23.5	57	35	6	19	M12	7.5	11.5	0.2	TS33	②TKY08D	QO·T1342R-○○
262M12A35	●	○	26	12.5	23.5	57	35	6	19	M12	7.5	11.5	0.2	TS33	②TKY08D	QO·T1342R-○○
322M16A40	●	○	32	17	28.5	63	40	6	24	M16	9.5	14.5	0.3	TS407	②TKY15D	QO·T1651R-○○
332M16A40	●	○	33	17	28.5	63	40	6	24	M16	9.5	14.5	0.3	TS407	②TKY15D	QO·T1651R-○○
352M16A40	●	○	35	17	28.5	63	40	6	24	M16	11	16	0.3	TS407	②TKY15D	QO·T1856R-○○
402M16A45	●	○	40	17	28.5	68	45	6	24	M16	12	18	0.3	TS55	②TKY25D	QO·T2062R-○○

*1 A3 : Max depth of cut to maintain the full two bottom insert contact with workpiece.

*2 ap : Maximum overall depth of cut.

Note) For the recommended cutting conditions, refer to pages C111 - C117 in C003J general catalogue or B021G Tools News.

SRM2



Standard Type

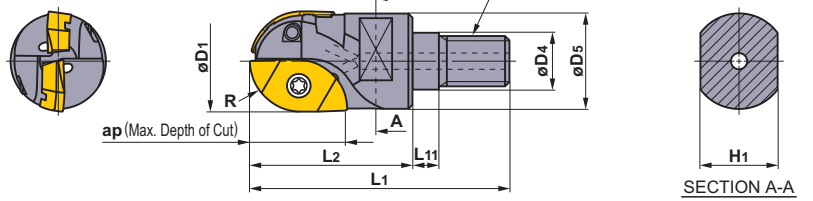

Long Cutting Edge Type

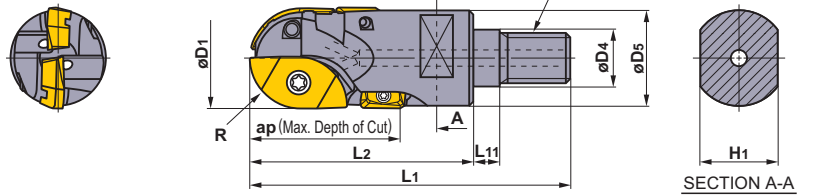

Right hand tool only.

Type	Order Number	Stock Coolant Hole	Dimensions (mm)											Mass (kg)	Inner Outer Clamp Screw	Peripheral Screw	Wrench	Inner	Outer	Peripheral
			R	D1	D4	D5	L1	L2	L11	H1	M	ap								
Standard type	SRM2160AM08S30	● ○	8	16	8.5	14.6	48	30	6	10	M8	12	0.1	TS25H	—	①TKY08D	SRG16C SRM16C-M	SRG16E SRM16E-M	—	
	2200AM10S35	● ○	10	20	10.5	18.6	54	35	6	14	M10	14	0.1	TS32	—	①TKY08D	SRG20C SRM20C-M	SRG20E SRM20E-M	—	
	2250AM12S40	● ○	12.5	25	12.5	23.5	62	40	6	19	M12	19	0.2	TS43	TS25	②TKY15T	SRG25C SRM25C-M	SRG25E SRM25E-M	—	
	2300AM16S45	● ○	15	30	17	28.3	68	45	6	24	M16	24	0.2	TS55	—	②TKY15T ③TKY08F	SRG30C SRM30C-M	SRG30E SRM30E-M	—	
	2320AM16S45	● ○	16	32	17	30.0	68	45	6	24	M16	28	0.2	TS55	TS43	②TKY25T ③TKY15F	SRG32C SRM32C-M	SRG32E SRM32E-M	—	
Long cutting edge type	SRM2200AM10L45	● ○	10	20	10.5	18.6	64	45	6	14	M10	30	0.2	TS32	TS25	①TKY08D	SRG20C SRM20C-M	SRG20E SRM20E-M	APMT1135 PDER-2	
	2250AM12L55	● ○	12.5	25	12.5	23.5	77	55	6	19	M12	37	0.3	TS43	TS25	②TKY15T ③TKY08F	SRG25C SRM25C-M	SRG25E SRM25E-M	APMT1135 PDER-2	
	2300AM16L60	● ○	15	30	17	28.3	83	60	6	24	M16	44	0.3	TS55	TS43	②TKY25T ③TKY15F	SRG30C SRM30C-M	SRG30E SRM30E-M	APMT1604 PDER-2	
	2320AM16L60	● ○	16	32	17	29.0	83	60	6	24	M16	44	0.3	TS55	TS43	②TKY25T ③TKY15F	SRG32C SRM32C-M	SRG32E SRM32E-M	APMT1604 PDER-2	

Note) For the recommended cutting conditions, refer to pages C138 - C141 in C003J general catalogue or B020G Tools News.

SCREW-IN TOOLS

ARX

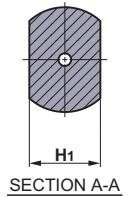
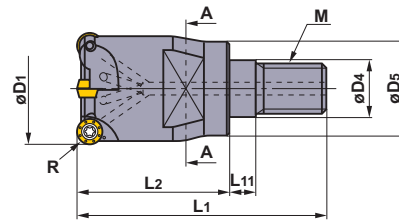
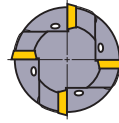

Right hand tool only.

Order Number	Stock	Coolant Hole	Number of Teeth	Dimensions (mm)									Mass (kg)	Clamp Screw	Wrench	Insert
	R			R	D1	D4	D5	L1	L2	L11	H1	M				
ARX25R163M08A30	●	○	3	2.5	16	8.5	14.7	48	30	6	10	M8	0.1	TPS20	TIP06F	RDMW0517M0E
173M08A30	●	○	3	2.5	17	8.5	14.5	48	30	6	10	M8	0.1	TPS20	TIP06F	RDMW0517M0E
204M10A30	●	○	4	2.5	20	10.5	18.6	49	30	6	14	M10	0.2	TPS20	TIP06F	RDMW0517M0E
224M10A30	●	○	4	2.5	22	10.5	18.5	49	30	6	14	M10	0.2	TPS20	TIP06F	RDMW0517M0E
255M12A35	●	○	5	2.5	25	12.5	23.6	57	35	6	19	M12	0.2	TPS20	TIP06F	RDMW0517M0E
ARX30R163M08A30	●	○	3	3.0	16	8.5	14.6	48	30	6	10	M8	0.1	TPS22	TIP07FS	RDMW0620M0E
173M08A30	●	○	3	3.0	17	8.5	14.5	48	30	6	10	M8	0.1	TPS22	TIP07FS	RDMW0620M0E
203M10A30	●	○	3	3.0	20	10.5	18.5	49	30	6	14	M10	0.2	TPS22	TIP07FS	RDMW0620M0E
224M10A30	●	○	4	3.0	22	10.5	18.5	49	30	6	14	M10	0.2	TPS22	TIP07FS	RDMW0620M0E
254M12A35	●	○	4	3.0	25	12.5	23.4	57	35	6	19	M12	0.2	TPS22	TIP07FS	RDMW0620M0E

Note) For the recommended cutting conditions, refer to pages C130 - C133 in C003J general catalogue or B066G Tools News.

ASX400

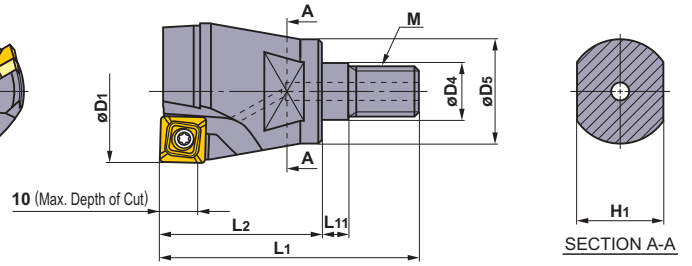
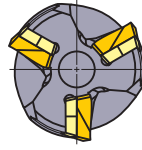

Right hand tool only.

Order Number	Stock R	Coolant Hole ○	Number of Teeth	Dimensions (mm)								Mass (kg)	Shim	Clamp Screw	Shim Screw	Wrench (Insert)	Wrench (Shim)	Insert
				D1	D4	D5	L1	L2	L11	H1	M							
ASX400R322AM1640	●	○	2	32	17	29	63	40	6	24	M16	0.3	—	TPS35	WCS503507H	TIP15T	HKY35R	① SO T12T308 PEER
403AM1645	●	○	3	40	17	29	68	45	6	24	M16	0.3	STASX400N	TPS35	WCS503507H	TIP15T	HKY35R	② WOEW12T308 PEE/TR-8C

Note) For the recommended cutting conditions, refer to pages C078 - C081 in C003J general catalogue or B023G Tools News.

SCREW-IN TOOLS

Straight Shank Arbor

Steel Shank Type

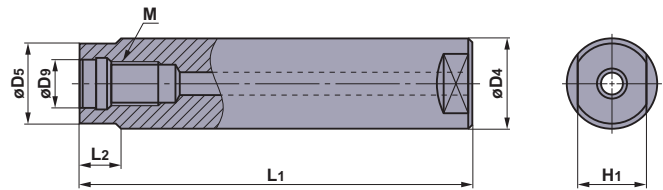

Type	Order Number	Stock	Coolant Hole	Dimensions (mm)						Mass (kg)	
				D9	D4	D5	L1	L2	H1		M
Steel Shank	SC16M08S100S	●	○	8.5	16	14.5	100	10	10	M8	0.1
	08S200L	●	○	8.5	16	14.5	200	10	10	M8	0.3
	SC20M10S120S	●	○	10.5	20	18.5	120	10	14	M10	0.3
	10S220L	●	○	10.5	20	18.5	220	10	14	M10	0.5
	SC25M12S125S	●	○	12.5	25	23.5	125	10	19	M12	0.4
	12S245L	●	○	12.5	25	23.5	245	10	19	M12	0.8
	SC32M16S140S	●	○	17	32	28.5	140	15	24	M16	0.8
16S280L	●	○	17	32	28.5	280	15	24	M16	1.6	

Carbide Shank Type

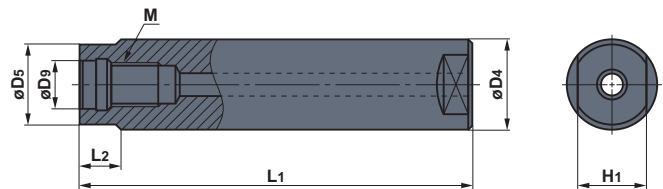

Type	Order Number	Stock	Coolant Hole	Dimensions (mm)						Mass (kg)	
				D9	D4	D5	L1	L2	H1		M
Carbide Shank	SC16M08S100SW	●	○	8.5	16	14.5	100	10	10	M8	0.2
	08S200LW	●	○	8.5	16	14.5	200	10	10	M8	0.5
	SC20M10S120SW	●	○	10.5	20	18.5	120	10	14	M10	0.5
	10S220LW	●	○	10.5	20	18.5	220	10	14	M10	0.9
	SC25M12S125SW	●	○	12.5	25	23.5	125	10	19	M12	0.8
	12S245LW	●	○	12.5	25	23.5	245	10	19	M12	1.5
	SC32M16S140SW	●	○	17	32	28.5	140	15	24	M16	1.4
16S280LW	●	○	17	32	28.5	280	15	24	M16	2.8	

BT Shank Arbor

BT30 Shank Arbor

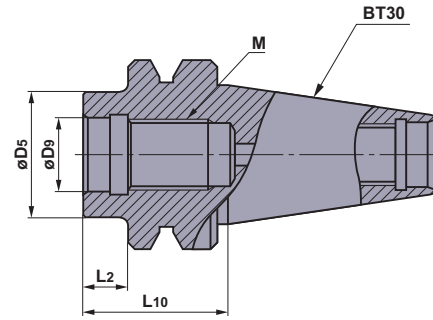

Order Number	Stock	Coolant Hole	Dimensions (mm)					Mass (kg)
			D9	D5	L10	L2	M	
SC16M08S10-BT30	●	○	8.5	14.5	32	10	M8	0.4
20M10S10-BT30	●	○	10.5	18.5	32	10	M10	0.4
25M12S10-BT30	●	○	12.5	23.5	32	10	M12	0.4
32M16S10-BT30	●	○	17.0	28.5	32	10	M16	0.4

BT40 Shank Arbor

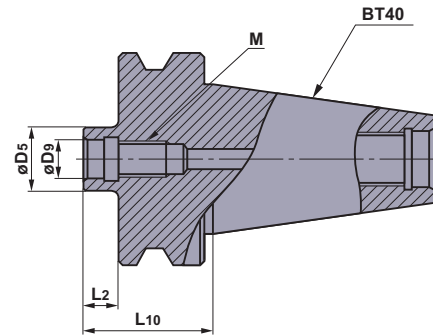

Order Number	Stock	Coolant Hole	Dimensions (mm)					Mass (kg)
			D9	D5	L10	L2	M	
SC16M08S10-BT40	●	○	8.5	14.5	37	10	M8	1.0
20M10S10-BT40	●	○	10.5	18.5	37	10	M10	1.0
25M12S10-BT40	●	○	12.5	23.5	37	10	M12	1.0
32M16S10-BT40	●	○	17.0	28.5	37	10	M16	1.0

HSK Shank Arbor

HSK63A Shank Arbor

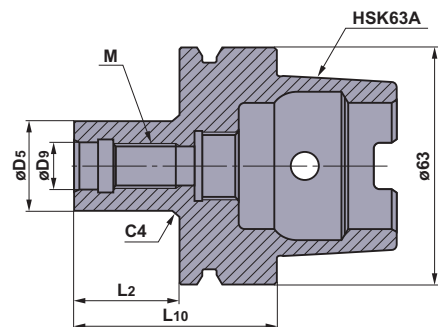

Order Number	Stock	Coolant Hole	Dimensions (mm)					Mass (kg)
			D9	D5	L10	L2	M	
SC16M08S22-HSK63A	●	○	8.5	14.5	48	22	M8	0.7
20M10S24-HSK63A	●	○	10.5	18.5	50	24	M10	0.7
25M12S27-HSK63A	●	○	12.5	23.5	53	27	M12	0.7
32M16S28-HSK63A	●	○	17.0	28.5	54	28	M16	0.8

SCREW-IN TOOLS

How to Install the Screw-in Head

- ① Thoroughly clean the clamp section of the head and the arbor with an air blower or brush before installation.
- ② Tighten the head at the recommended torque and ensure that there is no gap between the head and arbor.

Screw Size	Recommended Torque (Nm)	Wrench Size (mm)
M8	23	10
M10	46	14
M12	80	19
M16	90	24



- Cutting tools become extremely hot during cutting. Never touch them with bare hands after operation as this may produce risk of injuries or burns.
- Do not handle the cutting tools with bare hands as this may cause injuries.

For Your Safety

● Don't handle inserts and chips without gloves. ● Please machine within the recommended application range and exchange expired tools with new ones in advance of breakage. ● Please use safety covers and wear safety glasses. ● When using compounded cutting oils, please take fire precautions. ● When attaching inserts or spare parts, please use only the correct wrench or spanner. ● When using rotating tools, please make a trial run to check run-out, vibration and abnormal sounds etc.

MITSUBISHI MATERIALS CORPORATION



The Scope of the Registration:
Design, Development and
Production of Compacted
Carbide Tools and Carbide
Blocks



The Scope of the Registration:
Design, Development and
Production of Cutting Tools,
Wear-resistant Tools, Rock
Chipping Tools, Compound
Carbide Blanks and Coated
Products



MITSUBISHI MATERIALS CORPORATION Area Marketing & Operations Dept.

KFC bldg., 8F, 1-6-1, Yokoami, Sumida-ku, Tokyo 130-0015, Japan
TEL +81-3-5819-8772 FAX +81-3-5819-8774

MMC HARTMETALL GmbH

Comeniusstr.2, 40670, Meerbusch GERMANY
TEL +49-2159-9189-0 FAX +49-2159-918966

MITSUBISHI MATERIALS U.S.A. CORPORATION Headquarters

17401, Eastman Street, Irvine, California, 92614, USA
TEL +1-949-862-5100 FAX +1-949-862-5180

MMC METAL SINGAPORE PTE LTD.

10, Arumugam Road, #04-00 Lion Industrial Bldg., 409957, SINGAPORE
TEL +65-6743-9370 FAX +65-6749-1469

Mitsubishi Carbide Home page : <http://www.mitsubishicarbide.com>
(Tools specifications subject to change without notice.)