

IMPACT MIRACLE

End Mill Series

VFFDRB

New duplex corner radius and multi-flute geometry for high feed, stable machining of hardened steels.

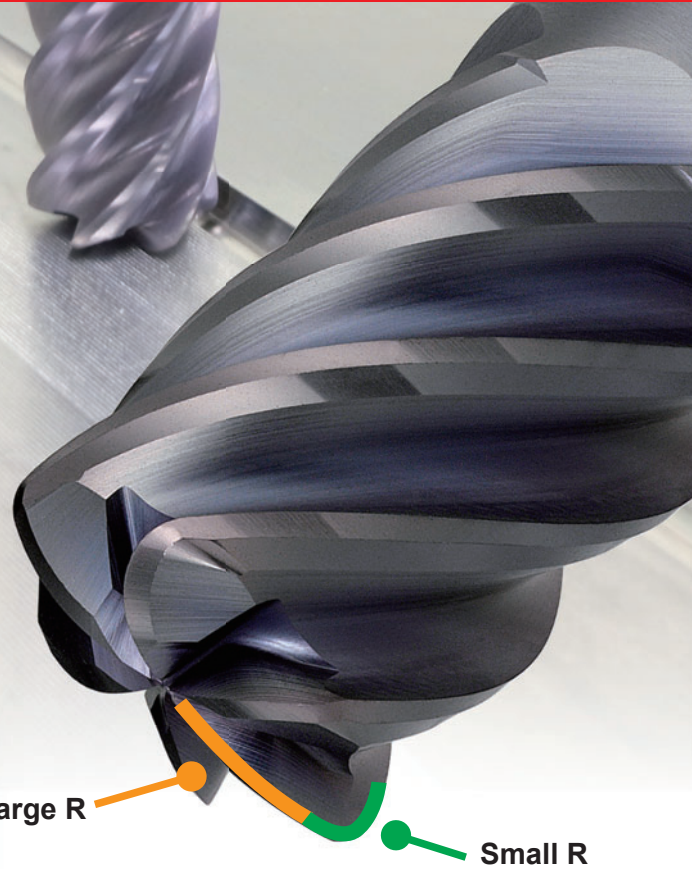

Cutting Performance

Tool life comparison in SKD11 (ø6)

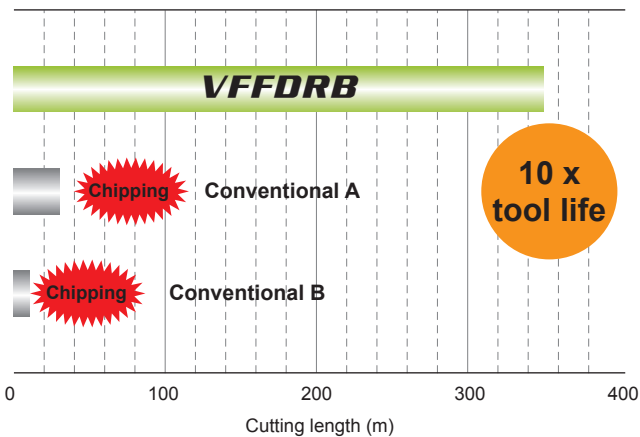

<Cutting conditions>
 Work material : SKD11 (60HRC)
 Tool size : VFFDRBD0600
 Revolution : 3,700 min⁻¹ (70 m/min)
 Feed rate : 5,920 mm/min (0.4 mm/tooth)
 Depth of cut : ap=0.3 mm, ae=1.5 mm
 Over hang : 18 mm (3D)
 Machining centre : Vertical M/C (HSK63)
 Cutting method : Air blow

VFFDRB
(Cutting length 350 m)

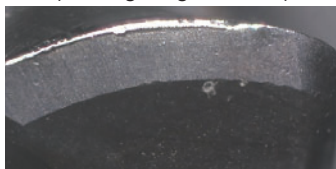

Conventional A
(Cutting length 30 m)

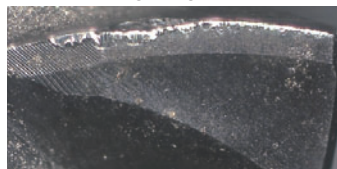

Conventional B
(Cutting length 5 m)

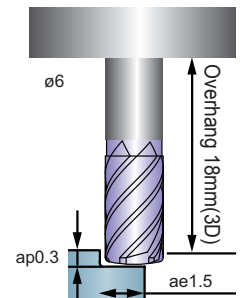
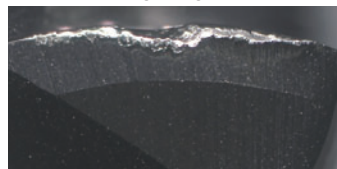

Features

High efficiency machining geometry

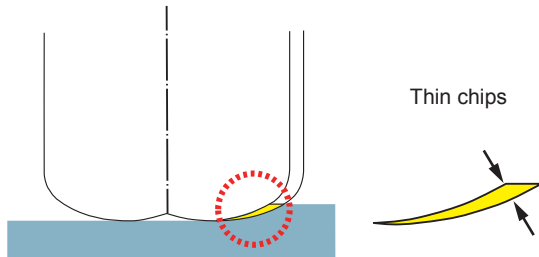

Thin chips and a long cutting edge combine to provide both high performance and long tool life.

Vibration control geometry

VFFDRB

Conventional radius

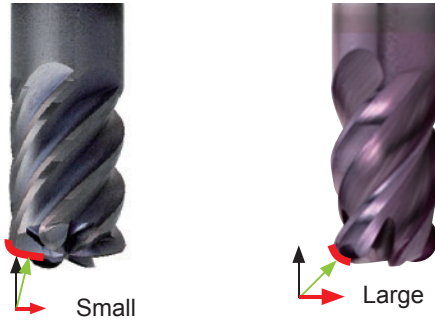

Reduced cutting resistance in the radial direction suppresses tool vibration and reduces deflection.

Performance and Application Range

High efficiency machining of high hardened steels over 60 HRC can be achieved.

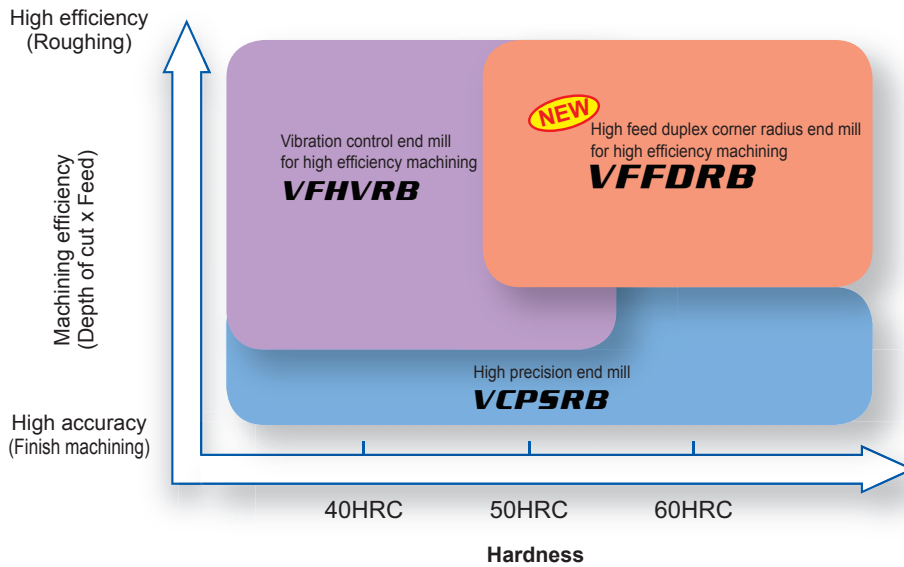

Application / Tool - Selection Chart

Content of processing	Hardened materials (Over 50 HRC)	Long overhangs (Over 5D)	High feed	Large ap (Over 0.05D)
High feed duplex corner radius end mill VFFDRB	◎	◎	◎	×
Vibration control end mill for high efficiency machining VFHVRB	○	○	○	◎

◎...First recommendation
○...Second recommendation
×...Not recommended

VFFDRB NEW

Duplex corner radius end mill, Short cut length, 4-6 flute, For high feed



Carbon Steel, Alloy Steel, Cast Iron (<30HRC)	Tool Steel, Pre-Hardened Steel, Hardened Steel (<=45HRC)	Hardened Steel (<=55HRC)	Hardened Steel (>55HRC)	Austenitic Stainless Steel	Titanium Alloy, Heat Resistant Alloy	Copper Alloy	Aluminium Alloy
○	○	◎	◎				

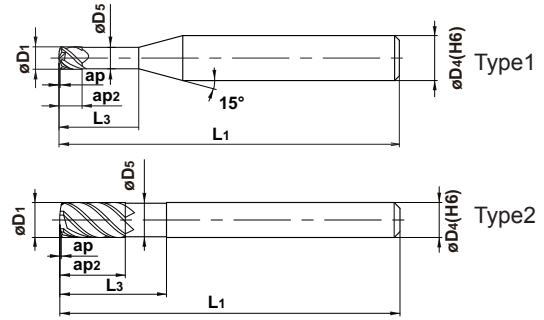
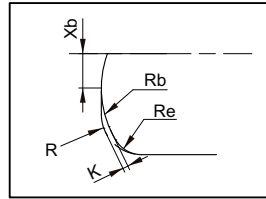

h6	D1 ≤ 12				
	0 - 0.020				
	D4=6	8 ≤ D4 ≤ 10	D4=12		
	0 - 0.008	0 - 0.009	0 - 0.011		

- High feed rate possible due to the duplex corner radius geometry.
- Multi-flutes enable high feed machining.

Unit : mm

Order Number	D1	R	ap	ap2	L3	D5	L1	D4	N	Duplex corner radius				α	Stock	Type
										K	Xb	Re	Rb			
VFFDRBD0300	3	0.64	0.18	3	10	2.8	60	6	4	0.08	0.375	0.5	2	2.1	●	1
VFFDRBD0400	4	0.71	0.25	4	12	3.8	60	6	4	0.13	0.5	0.5	3	1.9	●	1
VFFDRBD0600	6	0.92	0.36	9	18	5.6	80	6	4	0.21	0.75	0.6	5	1.7	●	2
VFFDRBD0800	8	1.16	0.44	12	24	7.6	90	8	6	0.22	1.6	0.8	4.5	1.7	●	2
VFFDRBD1000	10	1.47	0.57	15	30	9.4	100	10	6	0.28	2	1	5.5	1.7	●	2
VFFDRBD1200	12	1.77	0.7	18	36	11.4	110	12	6	0.34	2.4	1.2	6.5	1.8	●	2

D1 = Diameter ap2 = Length of Cut L1 = Overall Length K = Uncut portion
R = Corner R L3 = Neck Length D4 = Shank Dia. α = Max.Ramping Angle
ap = Max. Depth of Cut D5 = Neck Dia. N = Number of Flutes

RECOMMENDED CUTTING CONDITIONS

Face milling

Dia. (mm)	Carbon steel, Alloy steel (180–280HB), Mild steel (≤180HB) S45C, SCM440, SS400, S10C etc.						Prehardened steel (35–45HRC), Carbon steel, Alloy steel (280–350HB), Alloy tool steel (≤350HB), NAK, PX5, SNCM439, SKD, SKT etc.					
	vc (m/min)	n (min ⁻¹)	fz (mm/t.)	vf (mm/min)	ap (mm)	ae (mm)	vc (m/min)	n (min ⁻¹)	fz (mm/t.)	vf (mm/min)	ap (mm)	ae (mm)
3	80	8500	0.07	2400	0.12	1.5	100	11000	0.07	3100	0.12	1.5
4	80	6400	0.1	2600	0.16	2	100	8000	0.1	3200	0.16	2
6	80	4200	0.17	2900	0.24	3	100	5300	0.17	3600	0.24	3
8	80	3200	0.17	3300	0.32	4.8	100	4000	0.17	4100	0.32	4.8
10	80	2500	0.2	3000	0.4	6	100	3200	0.2	3800	0.4	6
12	80	2100	0.22	2800	0.48	7.2	100	2700	0.22	3600	0.48	7.2

Dia. (mm)	Hardened steel (40–55HRC), Ferritic and martensitic stainless steel (>200HB), Precipitation hardening stainless steel (<450HB), SKD61, SKT4, SUS431, SUS420J2, STAVAX, SUS630, SUS631, 15-5PH, 17-4PH etc.						Hardened steel (55–62HRC) SKD11 etc.					
	vc (m/min)	n (min ⁻¹)	fz (mm/t.)	vf (mm/min)	ap (mm)	ae (mm)	vc (m/min)	n (min ⁻¹)	fz (mm/t.)	vf (mm/min)	ap (mm)	ae (mm)
3	96	10200	0.091	3700	0.12	1.5	40	4200	0.05	840	0.12	1.5
4	97	7700	0.13	4000	0.16	2	40	3200	0.07	960	0.16	2
6	94	5000	0.22	4400	0.24	3	40	2100	0.15	1300	0.24	3
8	97	3850	0.221	5100	0.32	4.8	40	1600	0.15	1400	0.32	4.8
10	94	3000	0.25	4500	0.4	6	40	1300	0.17	1300	0.4	6
12	94	2500	0.28	4200	0.48	7.2	40	1100	0.2	1300	0.48	7.2

- 1) When ramping it is recommended to reduce the feed rate by 50%. The recommended ramping angle is 1 deg.
- 2) When the overhang is longer than 5D, reduce the spindle speed by 30% and the feed rate by 50%.
- 3) If there is a big change of cutting force at corners, or machin tool rigidity, reduce the spindle speed by 70% and the feed rate by 50%.

vc = Cutting Speed fz = Feed per Tooth ap = Axial Depth of Cut
n = Revolution vf = Feed Rate ae = Radial Width of Cut

● : Inventory maintained in Japan.

Cutting Performance

Tool life comparison when machining SKD61 (ø6 - 7D overhang)

VF-FDRB achieves more than 20 times longer tool life compared to competitors for extreme overhang applications (7D)

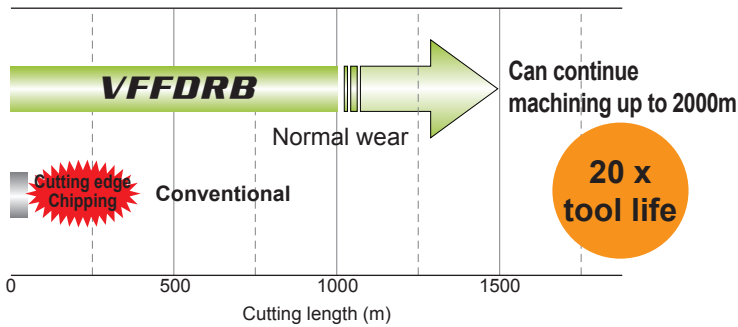

VFFDRB
(Cutting length 200 m)

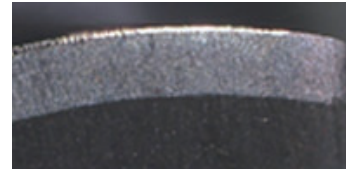

Conventional
(Cutting length 50 m)

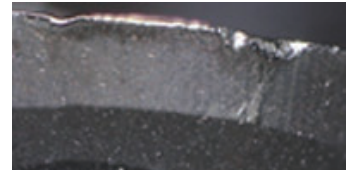

<Cutting conditions>

Work material : SKD61 (52HRC)
Tool size : VFFDRBD0600
Revolution : 6,400 min⁻¹ (120 m/min)
Feed rate : 6,400 mm/min (0.25 mm/tooth)
Depth of cut : ap=0.3 mm, ae=1.5 mm
Over hang : 42 mm (7D)
Machining centre : Vertical M/C (HSK63)
Cutting method : Air blow

Machining efficiency comparison when machining SKD61 ø10 - 3D overhang)

Feed rate increase x 3 compared to conventional radius end mills.

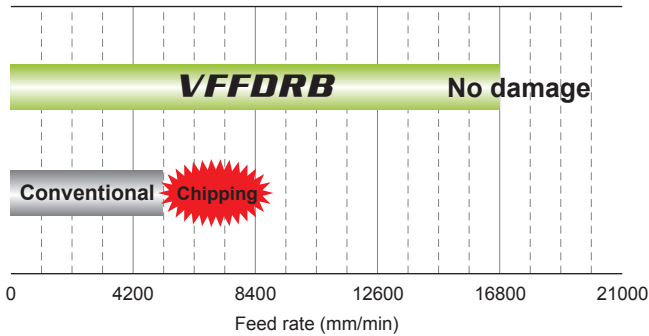

VFFDRB
6 flutes
Feed rate
(16800 mm/min)

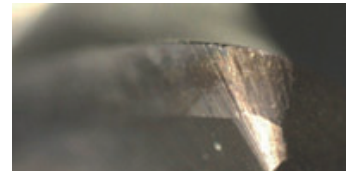

Conventional
Feed rate
(5250 mm/min)



<Cutting conditions>

Work material : SKD61 (52HRC)
Tool size : VFFDRBD1000
Revolution : 3,500 min⁻¹ (110 m/min)
Feed rate : 5,250-16,800 mm/min
Depth of cut : ap=0.3 mm, ae=5.5 mm
Over hang : 30 mm
Machining centre : Horizontal M/C (BT40)
Cutting method : Down cut, Air blow

For Your Safety

●Don't handle inserts and chips without gloves. ●Please machine within the recommended application range and exchange expired tools with new ones in advance of breakage. ●Please use safety covers and wear safety glasses. ●When using compounded cutting oils, please take fire precautions. ●When attaching inserts or spare parts, please use only the correct wrench or driver. ●When using rotating tools, please make a trial run to check run-out, vibration and abnormal sounds etc.

MITSUBISHI MATERIALS CORPORATION

MITSUBISHI MATERIALS CORPORATION

Overseas Sales Dept, Asian Region

KFC bldg., 8F, 1-6-1 Yokoami, Sumida-ku, Tokyo 130-0015, Japan
TEL +81-3-5819-8771 FAX +81-3-5819-8774

Overseas Sales Dept, European & American Region

KFC bldg., 8F, 1-6-1 Yokoami, Sumida-ku, Tokyo 130-0015, Japan
TEL +81-3-5819-8772 FAX +81-3-5819-8774

<http://www.mitsubishicarbide.com/en/>
(Tools specifications subject to change without notice.)