

For Machining of  
Hardened Steels

**IMPACT MIRACLE**  
End Mill Series

# IMPACT MIRACLE REVOLUTION

Series  
Expansion

## Revolutionary Hardened Steels

New coating provides amazingly long life



For Machining of Hardened Steels

# IMPACT MIRACLE End Mill Series

## IMPACT MIRACLE REVOLUTION



### IMPACT MIRACLE REVOLUTION Coating

The combination of the (Al, Cr, Si) N coating (newly-developed), which has a high oxidation temperature and high lubricity, together with the (Al, Ti, Si) N coating, which has better wear resistance and high adhesion, allows hardened steels with even greater strength to be maintained.

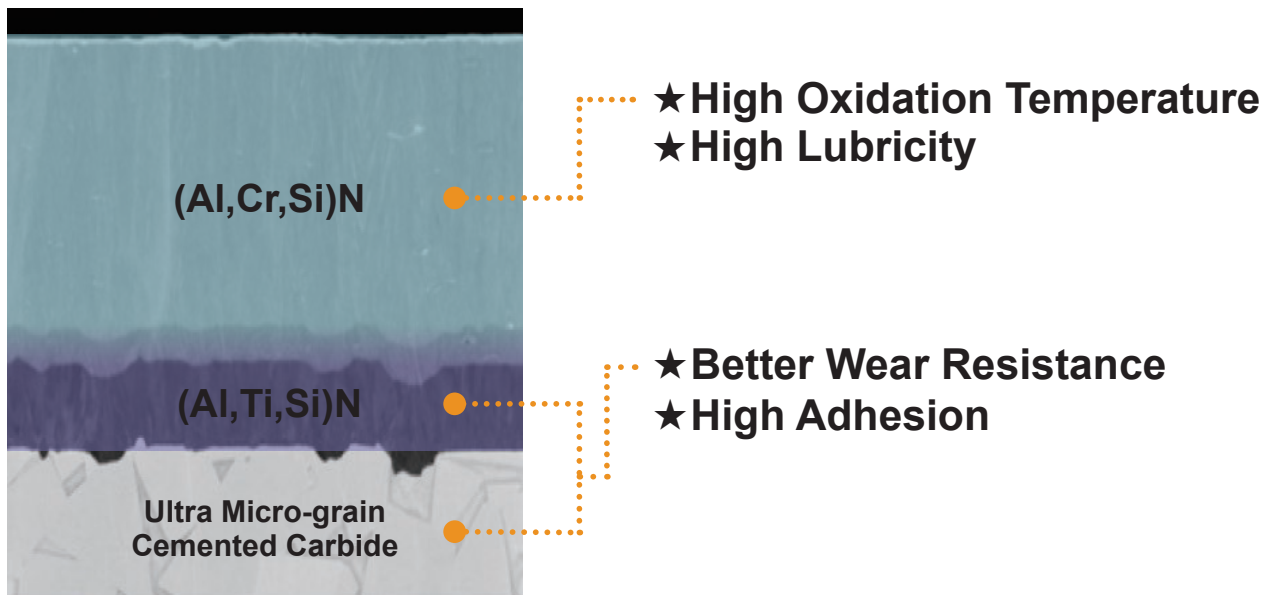

### Selection According to Work Materials Hardness

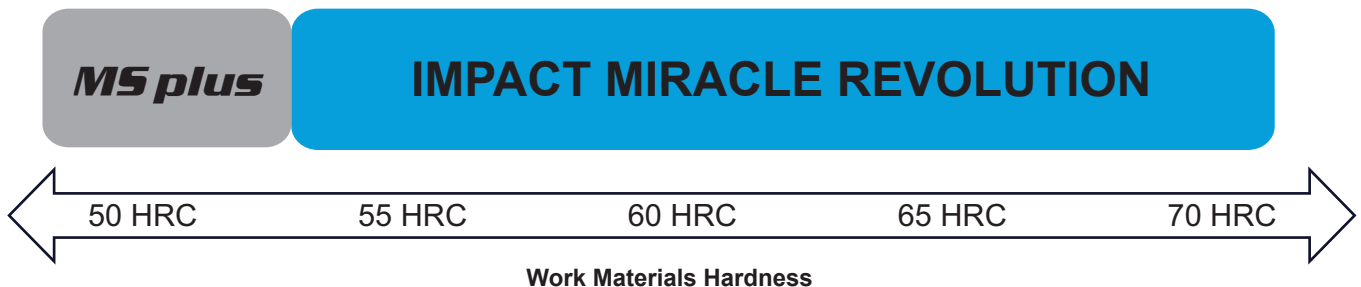

# Revolutionary Hardened Steel

## **VFR255B/VFR25B**

2 Flute Ball Nose End Mill

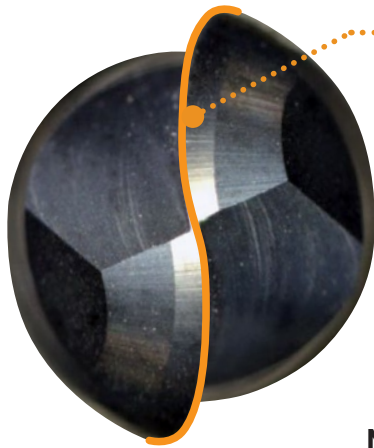

Strong S Curve



New Negative Cutting Edge Shape and Slow Helix Angle Cutting Edge

New Cutting Edge Shape: Optimization of the cutting edge curve, helix angle, and rake angle have improved the edge strength at all areas of the ball blades.

Carbide Substrate: High-grade material types ideal for high-hardness materials.

## **VFR25BF**

2 Flute Ball Nose End Mill for Mirror Finish Cutting

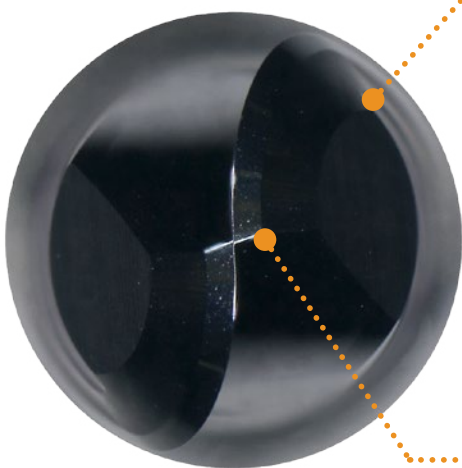

New ZERO- $\mu$  Surface

Newly-developed Surface Reforming Technology



New Ball Geometry for Mirror Finish Cutting

# For Machining of Hardened Steels

## VFR2SSB NEW

Ball nose, Short cut length, 2 flute, Short shank



Carbon Steel, Alloy Steel, Cast Iron (<30HRC)	Tool Steel, Pre-hardened Steel, Hardened Steel (≤45HRC)	Hardened Steel (≤55HRC)	Hardened Steel (>55HRC)	Austenitic Stainless Steel	Titanium Alloy, Heat Resistant Alloy	Copper Alloy	Aluminum Alloy
	○	◎	◎				

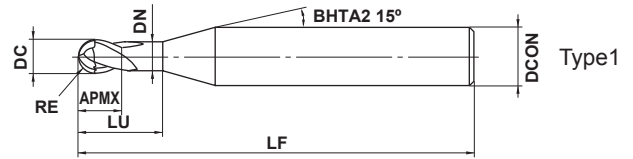

<b>R</b>	RE ≤ 6				
	±0.005				
<b>h5</b>	4 ≤ DCON ≤ 6	8 ≤ DCON ≤ 10	DCON = 12		
	$0 \begin{matrix} - \\ -0.005 \end{matrix}$	$0 \begin{matrix} - \\ -0.006 \end{matrix}$	$0 \begin{matrix} - \\ -0.008 \end{matrix}$		

● Optimization of the cutting edge curve, helix angle, and rake angle have improved the edge strength at all areas of the ball blades.

Order Number	RE	DC	APMX	LU	DN	LF	DCON	No.F <sup>*</sup>	Stock	Type
VFR2SSBR0050S04	0.5	1	1	2	0.94	40	4	2	●	1
VFR2SSBR0050	0.5	1	1	2	0.94	40	6	2	●	1
VFR2SSBR0075S04	0.75	1.5	1.5	3	1.44	40	4	2	●	1
VFR2SSBR0075	0.75	1.5	1.5	3	1.44	40	6	2	●	1
VFR2SSBR0100	1	2	2	4	1.9	45	6	2	●	1
VFR2SSBR0150	1.5	3	3	6	2.9	45	6	2	●	1
VFR2SSBR0200	2	4	4	8	3.9	45	6	2	●	1
VFR2SSBR0250	2.5	5	5	10	4.9	50	6	2	●	1
VFR2SSBR0300	3	6	6	12	5.85	50	6	2	●	2
VFR2SSBR0400	4	8	8	14	7.85	60	8	2	●	2
VFR2SSBR0500	5	10	10	18	9.7	70	10	2	●	2
VFR2SSBR0600	6	12	12	22	11.7	75	12	2	●	2

\* Number of Flutes

● : Inventory maintained. ★ : Inventory maintained in Japan.

# VFR2SB

Ball nose, Short cut length, 2 flute



Carbon Steel, Alloy Steel, Cast Iron (<30HRC)	Tool Steel, Pre-hardened Steel, Hardened Steel (≤45HRC)	Hardened Steel (≤55HRC)	Hardened Steel (>55HRC)	Austenitic Stainless Steel	Titanium Alloy, Heat Resistant Alloy	Copper Alloy	Aluminum Alloy
	○	◎	◎				

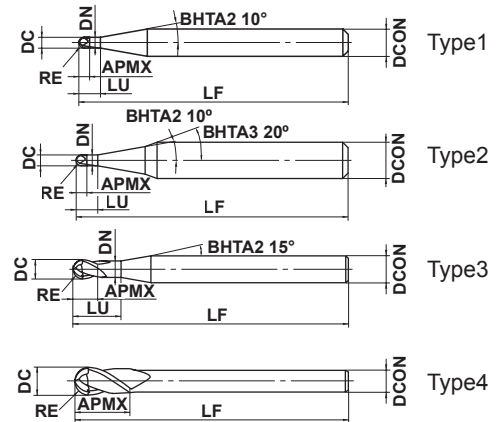

R	RE ≤ 6	RE > 6			
	±0.005	±0.010			
h5	DCON = 3	4 ≤ DCON ≤ 6	8 ≤ DCON ≤ 10	DCON = 12, 16	DCON = 20
	-0.004	-0.005	-0.006	-0.008	-0.009

- Optimization of the cutting edge curve, helix angle, and rake angle have improved the edge strength at all areas of the ball blades.

Order Number	RE	DC	APMX	LU	DN	LF	DCON	No.F <sup>*</sup>	Stock	Type
VFR2SBR0010	0.1	0.2	0.2	0.4	0.17	45	4	2	●	1
VFR2SBR0010S06	0.1	0.2	0.2	0.4	0.17	50	6	2	●	2
VFR2SBR0015	0.15	0.3	0.3	0.6	0.27	45	4	2	●	1
VFR2SBR0015S06	0.15	0.3	0.3	0.6	0.27	50	6	2	●	2
VFR2SBR0020	0.2	0.4	0.4	0.8	0.36	45	4	2	●	1
VFR2SBR0020S06	0.2	0.4	0.4	0.8	0.36	50	6	2	●	2
VFR2SBR0030	0.3	0.6	0.6	1.2	0.56	45	4	2	●	3
VFR2SBR0030S06	0.3	0.6	0.6	1.2	0.56	50	6	2	●	3
VFR2SBR0040	0.4	0.8	0.8	1.6	0.76	45	4	2	●	3
VFR2SBR0040S06	0.4	0.8	0.8	1.6	0.76	50	6	2	●	3
VFR2SBR0050	0.5	1	1	2	0.94	45	4	2	●	3
VFR2SBR0050S06	0.5	1	1	2	0.94	50	6	2	●	3
VFR2SBR0060	0.6	1.2	1.2	2.4	1.14	45	4	2	●	3
VFR2SBR0060S06	0.6	1.2	1.2	2.4	1.14	50	6	2	●	3
VFR2SBR0070	0.7	1.4	1.4	2.8	1.34	45	4	2	●	3
VFR2SBR0070S06	0.7	1.4	1.4	2.8	1.34	50	6	2	●	3
VFR2SBR0075	0.75	1.5	1.5	3	1.44	45	4	2	●	3
VFR2SBR0075S06	0.75	1.5	1.5	3	1.44	50	6	2	●	3
VFR2SBR0080	0.8	1.6	1.6	3.2	1.54	45	4	2	●	3
VFR2SBR0080S06	0.8	1.6	1.6	3.2	1.54	50	6	2	●	3
VFR2SBR0090	0.9	1.8	1.8	3.6	1.74	45	4	2	●	3
VFR2SBR0090S06	0.9	1.8	1.8	3.6	1.74	50	6	2	●	3
VFR2SBR0100	1	2	2	4	1.9	50	4	2	●	3
VFR2SBR0100S06	1	2	2	4	1.9	60	6	2	●	3
VFR2SBR0125S06	1.25	2.5	2.5	5	2.4	60	6	2	●	3
VFR2SBR0150S03	1.5	3	3	—	—	60	3	2	●	4
VFR2SBR0150	1.5	3	3	6	2.9	70	6	2	●	3
VFR2SBR0200S04	2	4	4	—	—	60	4	2	●	4
VFR2SBR0200	2	4	4	8	3.9	70	6	2	●	3
VFR2SBR0250	2.5	5	5	10	4.9	80	6	2	●	3
VFR2SBR0300	3	6	12	—	—	80	6	2	●	4
VFR2SBR0400	4	8	14	—	—	90	8	2	●	4
VFR2SBR0500	5	10	18	—	—	100	10	2	●	4
VFR2SBR0600	6	12	22	—	—	110	12	2	●	4
VFR2SBR0800	8	16	30	—	—	140	16	2	★	4
VFR2SBR1000	10	20	38	—	—	160	20	2	★	4

\* Number of Flutes

# For Machining of Hardened Steels

Ball nose, Short cut length, 2 flute, Short shank **VFR255B**

Ball nose, Short cut length, 2 flute **VFR25B**

## Recommended Cutting Conditions

(mm)

Work Material	Hardened Steels (45—52HRC)						Hardened Steels (55—62HRC)						Hardened Steels (62—70HRC)					
	AISI H13						AISI D2						AISI W1, AISI M2					
	RE	$\alpha \leq 15^\circ$		$\alpha > 15^\circ$		ap	ae	$\alpha \leq 15^\circ$		$\alpha > 15^\circ$		ap	ae	$\alpha \leq 15^\circ$		$\alpha > 15^\circ$		ap
n (min <sup>-1</sup> )		vf (mm/min)	n (min <sup>-1</sup> )	vf (mm/min)	n (min <sup>-1</sup> )			vf (mm/min)	n (min <sup>-1</sup> )	vf (mm/min)	n (min <sup>-1</sup> )			vf (mm/min)	n (min <sup>-1</sup> )	vf (mm/min)	n (min <sup>-1</sup> )	
<b>R 0.1</b>	40000	320	40000	240	0.003	0.02	40000	320	40000	160	0.003	0.02	40000	320	40000	160	0.002	0.02
<b>R 0.15</b>	40000	640	40000	560	0.01	0.03	40000	640	40000	400	0.007	0.03	40000	640	40000	400	0.005	0.03
<b>R 0.2</b>	40000	1600	40000	1200	0.02	0.04	40000	1400	40000	1000	0.015	0.04	40000	1200	40000	1000	0.01	0.04
<b>R 0.3</b>	40000	3200	40000	1600	0.03	0.06	40000	2800	40000	1200	0.025	0.06	40000	2000	40000	1200	0.02	0.06
<b>R 0.4</b>	40000	6400	40000	2400	0.05	0.08	40000	4000	40000	1600	0.04	0.08	40000	2800	40000	1600	0.03	0.08
<b>R 0.5</b>	40000	8000	40000	3200	0.06	0.10	40000	5600	40000	2400	0.05	0.10	40000	3600	32000	1300	0.04	0.10
<b>R 0.75</b>	40000	9600	40000	4000	0.09	0.15	40000	7200	32000	2500	0.075	0.15	32000	4500	21000	1200	0.05	0.15
<b>R 1</b>	40000	9600	39000	4700	0.11	0.20	40000	8000	24000	2400	0.1	0.20	24000	3800	16000	1000	0.07	0.20
<b>R 1.25</b>	40000	10400	32000	4500	0.12	0.25	37000	8100	19000	2300	0.11	0.25	19000	3400	13000	1000	0.08	0.25
<b>R 1.5</b>	40000	12000	27000	4300	0.13	0.30	32000	7700	16000	2200	0.12	0.30	16000	3200	11000	880	0.09	0.30
<b>R 2</b>	32000	10880	20000	3600	0.15	0.40	24000	6200	12000	1900	0.13	0.40	12000	2400	8000	800	0.1	0.40
<b>R 2.5</b>	25000	9000	16000	2900	0.20	0.50	19000	5300	9600	1700	0.15	0.50	9600	2100	6000	600	0.1	0.50
<b>R 3</b>	21000	8400	13000	2600	0.25	0.60	16000	4800	8000	1600	0.2	0.60	8000	1700	5000	600	0.11	0.60
<b>R 4</b>	16000	6400	10000	2000	0.30	0.80	12000	3600	6000	1200	0.2	0.80	6000	1400	4000	480	0.11	0.80
<b>R 5</b>	13000	5200	8000	1700	0.50	1.00	10000	3200	4800	960	0.2	1.00	4800	1100	3000	420	0.12	1.00
<b>R 6</b>	9000	3600	6000	1300	0.50	1.20	7000	2200	3600	720	0.3	1.20	3600	860	2200	310	0.12	1.20
<b>R 8</b>	6000	2400	4000	1000	0.50	1.60	5000	1600	2500	500	0.3	1.60	2500	650	1500	240	0.15	1.60
<b>R10</b>	4500	1800	3000	780	0.50	2.00	4000	1300	1800	360	0.3	2.00	1800	470	1000	160	0.15	2.00

Depth of Cut

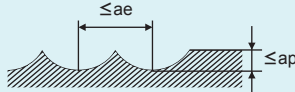

(Note 1)  $\alpha$  is the inclination angle of the machined surface.

(Note 2) If the depth of cut is smaller, the revolution and the feed rate can be increased. Please reduce the feed rate when the surface finish is important.

(Note 3) If the rigidity of the machine or the work materials installation is very low, or chattering and noise are generated, reduce the revolution and the feed rate proportionately.

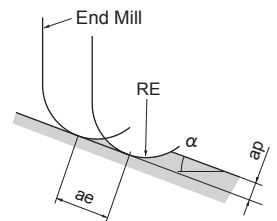

ae=Pick Feed

# VFR2SBF

Ball nose, Short cut length, 2 flute, For mirror finish cutting



Carbon Steel, Alloy Steel, Cast Iron (<30HRC)	Tool Steel, Pre-hardened Steel, Hardened Steel (≤45HRC)	Hardened Steel (≤55HRC)	Hardened Steel (>55HRC)	Austenitic Stainless Steel	Titanium Alloy, Heat Resistant Alloy	Copper Alloy	Aluminum Alloy
○	◎	◎	◎				

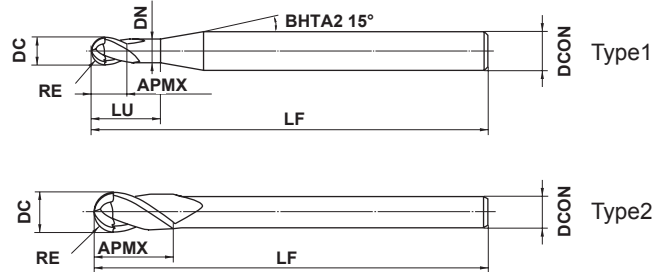

R	RE ≤ 3				
	±0.010				
h5	4 ≤ DCON ≤ 6				
	0 - 0.005				

● New ball geometry for mirror finish cutting.

Order Number	RE	DC	APMX	LU	DN	LF	DCON	No.F <sup>*</sup>	Stock	Type
VFR2SBFR0050	0.5	1	1	2	0.94	45	4	2	●	1
VFR2SBFR0075	0.75	1.5	1.5	3	1.44	45	4	2	●	1
VFR2SBFR0100	1	2	2	4	1.9	60	6	2	●	1
VFR2SBFR0125	1.25	2.5	2.5	5	2.4	60	6	2	●	1
VFR2SBFR0150	1.5	3	3	6	2.9	70	6	2	●	1
VFR2SBFR0200	2	4	4	8	3.9	70	6	2	●	1
VFR2SBFR0250	2.5	5	5	10	4.9	80	6	2	●	1
VFR2SBFR0300	3	6	6	—	—	80	6	2	●	2

\* Number of Flutes

● : Inventory maintained.



## VFR25BF

Ball nose, Short cut length, 2 flute, For mirror finish cutting

### Recommended Cutting Conditions

(mm)

RE (mm)	Carbon Steels, Alloy Steels (180–280HB) Alloy Tool Steels ( $\leq 350\text{HB}$ ), Pre-hardened Steels (35–45HRC) Hardened Steels (45–52HRC), Hardened Steels (55–62HRC) AISI 1045, AISI 4140, AISI P21, AISI P20, SKD, SKT, AISI H13, AISI L6, AISI D2						Hardened Steels (62–70HRC) AISI W1, AISI M2					
	$\alpha \leq 15^\circ$		$\alpha > 15^\circ$		ap	ae	$\alpha \leq 15^\circ$		$\alpha > 15^\circ$		ap	ae
	n ( $\text{min}^{-1}$ )	vf (mm/min)	n ( $\text{min}^{-1}$ )	vf (mm/min)			n ( $\text{min}^{-1}$ )	vf (mm/min)	n ( $\text{min}^{-1}$ )	vf (mm/min)		
<b>R 0.5</b>	40000	800	40000	800	0.007	0.007	40000	560	40000	560	0.005	0.005
<b>R 0.75</b>	40000	800	40000	800	0.009	0.009	40000	560	40000	560	0.007	0.007
<b>R 1.0</b>	35000	1050	35000	1050	0.011	0.011	35000	700	35000	700	0.009	0.009
<b>R 1.25</b>	35000	1050	35000	1050	0.013	0.013	35000	700	35000	700	0.011	0.011
<b>R 1.5</b>	35000	1050	35000	1050	0.015	0.015	35000	700	35000	700	0.013	0.013
<b>R 2.0</b>	25000	1000	25000	1000	0.017	0.017	25000	750	25000	750	0.015	0.015
<b>R 2.5</b>	25000	1000	25000	1000	0.020	0.020	25000	750	25000	750	0.015	0.015
<b>R 3.0</b>	25000	1000	25000	1000	0.020	0.020	25000	750	25000	750	0.015	0.015

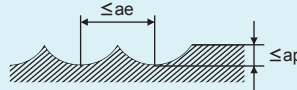

(Note 1) The tools are recommended for use only in finish machining.

(Note 2) Air blowing or oil mist is recommended as coolants.

(Note 3) Note the following points when using the tools.

- Avoid using equipment abruptly without proper preparation. After sufficiently energizing equipment, ensure that there will be no changes to the depth of cut such as due to elongation of the main axis during machining.
- If the tools are used immediately after rough machining of a surface, large uneven areas (cusp heights) will cause deflection of the tools and waviness of the machined surface. Therefore, it is recommended to add a medium finish machining process which uses the same value of ae as indicated in the table above.

(Note 4)  $\alpha$  is the inclination angle of the machined surface.

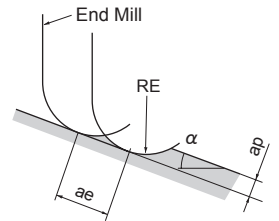

ae = Pick Feed



# Application Example

## VFR25B

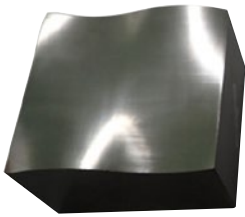

**ASP23  
(62HRC)**



**AISI M2  
(64HRC)**

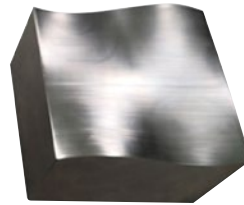

**HAP72  
(68HRC)**

<Cutting Conditions>  
 Workpiece : High Speed Steel  
 1.969"x1.969"x1.969"  
 Tool : VFR25BR0300  
 Cutting Mode : Air Blow  
 Machine : Vertical MC

### Rough Machining Shape

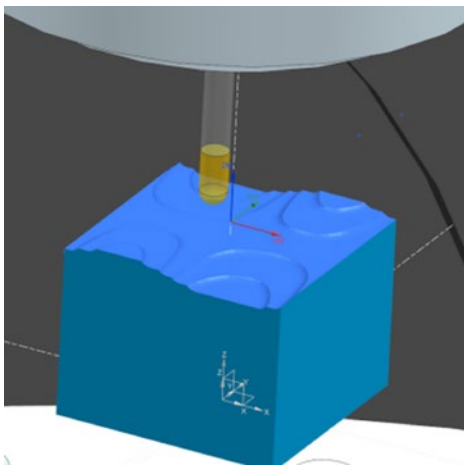

### Medium Finish and Finish (Tilt Angle 30°)

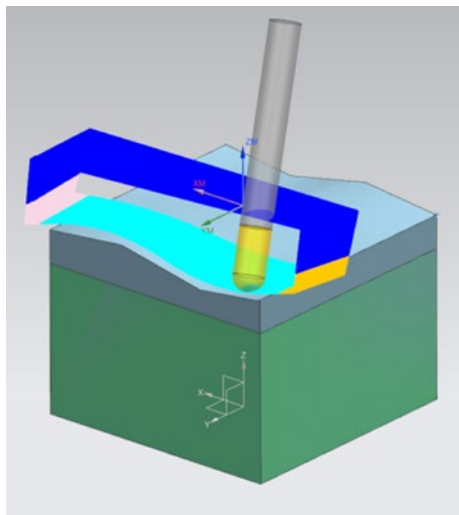

**Cutting Time : 234 min  
 Tools Used : 4**

(inch)

Process	RE	n (min <sup>-1</sup> )	vf (IPM)	ap	ae	Finishing Allowance	Cutting Time (h:m:s)	Number of Tools
Rough Machining with Contour Line	<b>R 3.0mm</b>	12000	63.0	.014	.039	.008	1:01:45	2
Medium Finish Machining with Scan Line	<b>R 3.0mm</b>	8000	19.7	.012	.004	.002	0:49:15	1
Finish Machining with Scan Line	<b>R 3.0mm</b>	12000	27.6	.004	.001	—	2:03:19	1

## Application Example

# VFR25BF

Workpiece : Pre-hardened Steel

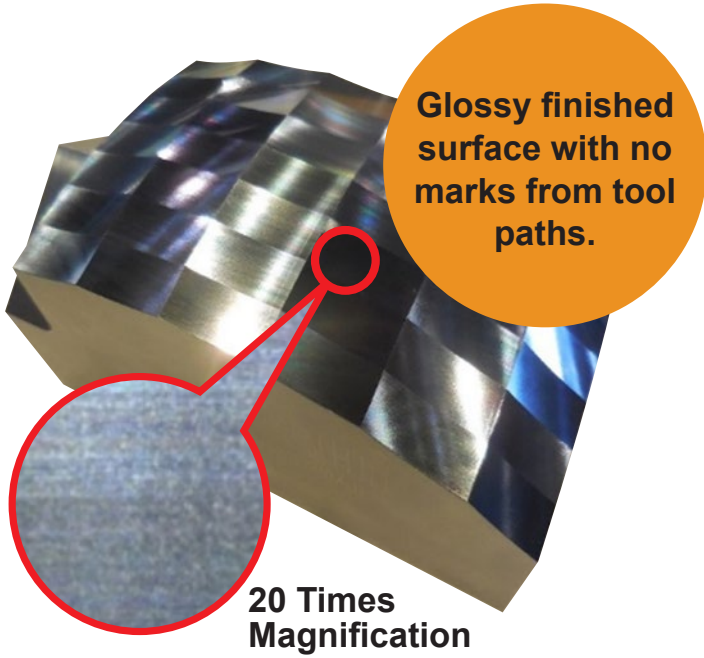

Indexed 5-axis machining can prevent machining at the tips of ball nose end mills.

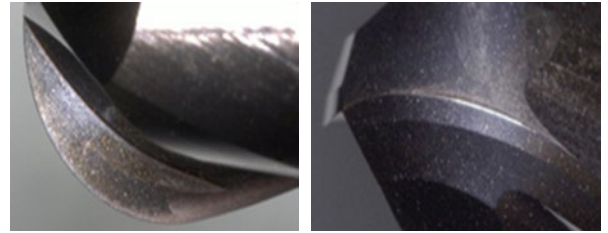

Excellent tool conditions after 31 hours of finish machining.

A surface roughness of Rz: 31.496 μ-inch or lower can be achieved.

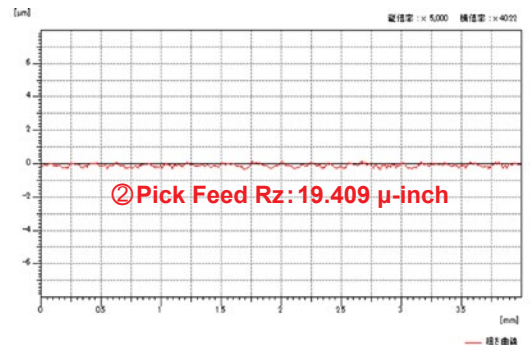
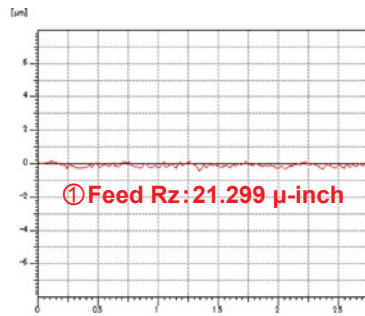
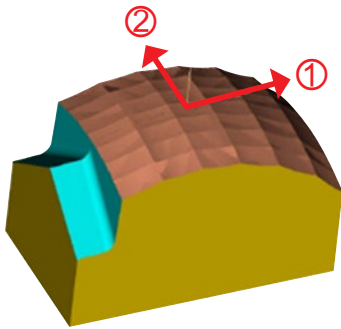

## Cutting Conditions Holder : HSK-A63

(inch)

Process	Order Number	Coolant	n (min <sup>-1</sup> )	vc (SFM)	vf (IPM)	fz (IPT)	ap	ae	Finishing Allowance	Cutting Time (h : m)
Rough Machining Side Finish Machining	VQMHVRBD1600R500	Air Blow	3000 2000	490 330	70.9 9.4	.0059 .0012	1.260 —	.039 —	.008 0	0:24
Chamfer and Medium Finish Machining on the Top	MP2SBR0300	Air Blow	13000	805	102.4	.0039	Along the Surface p0.1		.001	0:46
Top Finish Machining	VFR2SBFR0300	MQL	20000	1230	23.6	.0006	Along the Surface p0.015		0	31:10

# Cutting Performance

## AISI H13 (52HRC)

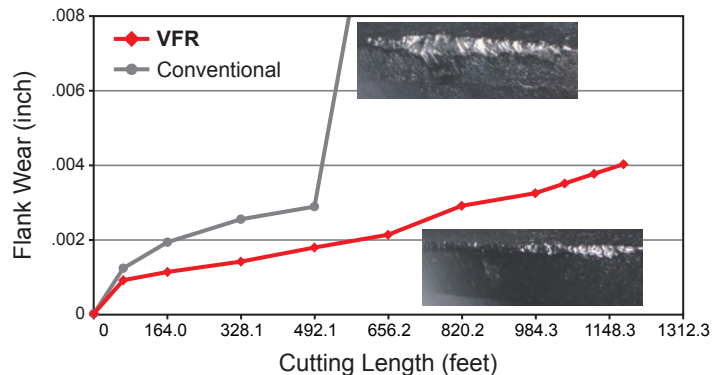

### <Cutting Conditions>

Work Material : AISI H13 (52HRC)  
 Tool : VFR2SBR0300  
 Revolution : n=17000 min<sup>-1</sup>  
 Table Feed : vf=66.9 IPM  
 Feed per Tooth : fz=.002 IPT  
 Depth of Cut : ap=.079 inch, ae=.012 inch  
 Overhang Length : .866 inch  
 Cutting Mode : Air blow  
 Machine : Vertical MC (HSK-A63)

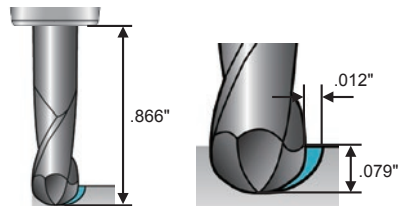

## AISI D2 (60HRC)

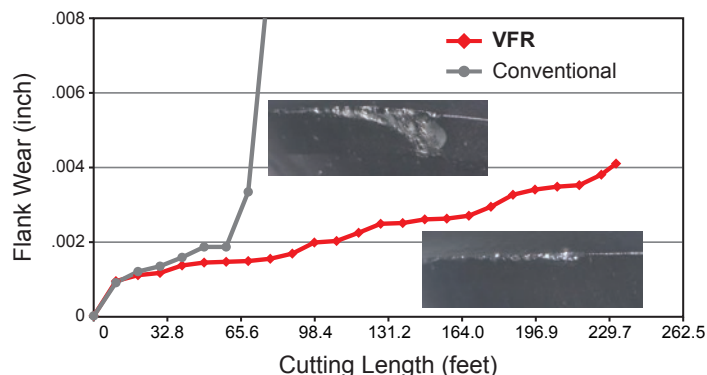

### <Cutting Conditions>

Work Material : AISI D2 (60HRC)  
 Tool : VFR2SBR0300  
 Revolution : n=5400 min<sup>-1</sup>  
 Table Feed : vf=21.3 IPM  
 Feed per Tooth : fz=.002 IPT  
 Depth of Cut : ap=.079 inch ae=.008 inch  
 Overhang Length : .866 inch  
 Cutting Mode : Air Blow  
 Machine : Vertical MC (HSK-A63)

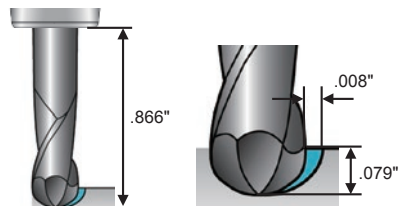

## ASP23 (62HRC)

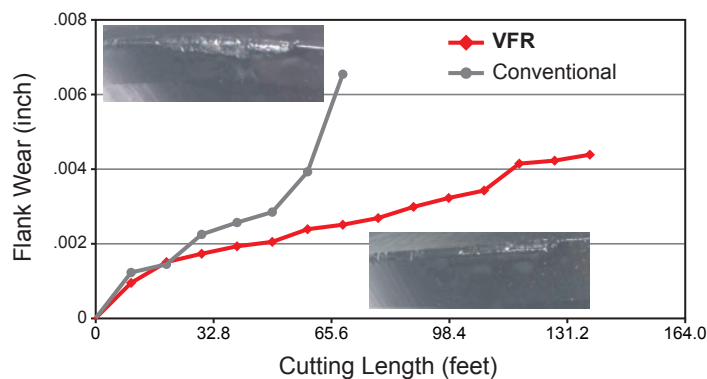

### <Cutting Conditions>

Work Material : ASP23 (62HRC)  
 Tool : VFR2SBR0300  
 Revolution : n=5400 min<sup>-1</sup>  
 Table Feed : vf=21.3 IPM  
 Feed per Tooth : fz=.002 IPT  
 Depth of Cut : ap=.079 inch, ae=.008 inch  
 Overhang Length : .866 inch  
 Cutting Mode : Air Blow  
 Machine : Vertical MC (HSK-A63)

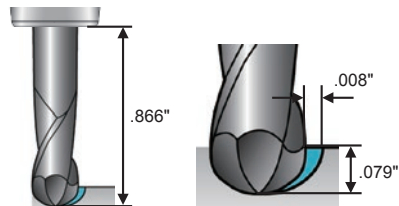

## AISI M2 (64HRC)

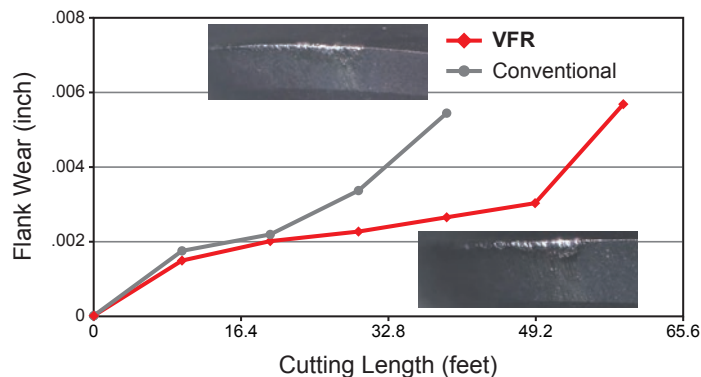

### <Cutting Conditions>

Work Material : AISI M2 (64HRC)  
 Tool : VFR2SBR0300  
 Revolution : n=5400 min<sup>-1</sup>  
 Table Feed : vf=21.3 IPM  
 Feed per Tooth : fz=.002 IPT  
 Depth of Cut : ap=.079 inch, ae=.008 inch  
 Overhang Length : .866 inch  
 Cutting Mode : Air Blow  
 Machine : Vertical MC (HSK-A63)

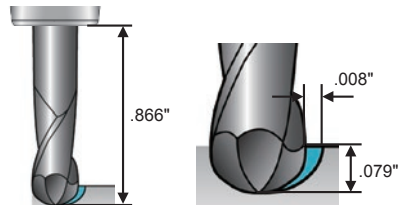

# AISI H13 (52 HRC) Comparison of Cutting Surface

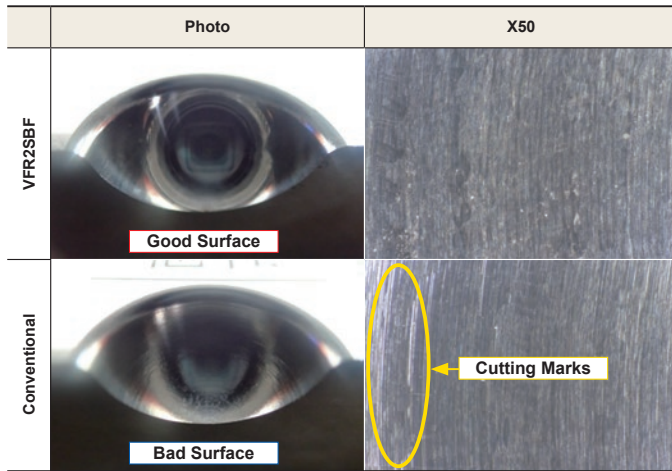

## Model Shape

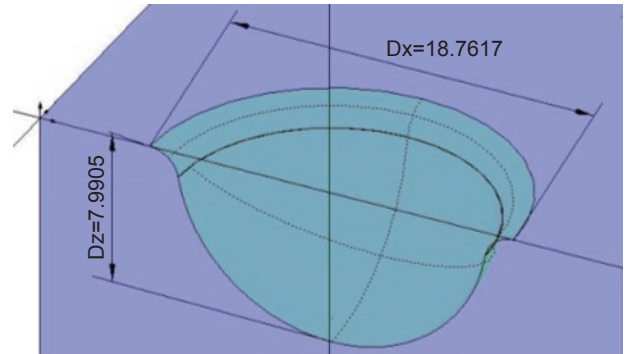

### <Cutting Conditions>

Workpiece : AISI H13 (52HRC)  
 Tool : VFR2SBFR0300  
 Revolution :  $n=32000 \text{ min}^{-1}$   
 Cutting Speed :  $vc=1980 \text{ SFM}$   
 Table Feed :  $vf=50.4 \text{ IPM}$

Feed per Tooth :  $fz=.001 \text{ IPT}$   
 Depth of Cut :  $ap=.001 \text{ inch}, ae=.001 \text{ inch}$   
 Overhang Length :  $.591 \text{ inch}$   
 Cutting Mode : Air Blow  
 Machine : Vertical MC (HSK-E25)

### For your safety

●Don't touch breakers and chips without gloves. ●Please machine within recommended application range, and exchange expired tools with new parts in advance. ●Please use safety cover and wear safety glasses. ●When using compounded cutting oils, please take fire prevention. ●When attaching inserts or spare parts, please use the attached wrench or driver. ●When using tools in revolution machining, please make a trial run to check run-out, vibration, abnormal sounds etc.

## MITSUBISHI MATERIALS U.S.A. CORPORATION

Customer Service : 800-523-0800  
 Technical Service : 800-486-2341

**LOS ANGELES HEAD OFFICE**  
 11250 Slater Avenue, Fountain Valley, CA 92708  
 TEL : 714-352-6100 FAX : 714-668-1320

**CHICAGO OFFICE**  
 1314B North Plum Grove Road, Schaumburg, IL 60173  
 TEL : 847-252-6300 FAX : 847-519-1732

**TORONTO OFFICE**  
 3535 Laird Road, Units 15 & 16, Mississauga, Ontario, L5L 5Y7, Canada  
 TEL : 905-814-0240 FAX : 905-814-0245

**MMC METAL DE MEXICO, S.A. DE C.V.**  
 Av. La Cañada No.16, Parque Industrial Bernardo Quintana,  
 El Marques, Queretaro, CP76246, Mexico  
 TEL : +52-442-221-6136 FAX : +52-442-221-6134

**URL : <http://www.mitsubishicarbide.com>**  
 (Tools specifications subject to change without notice.)