

For Ultra-high Speed, Super Efficient Machining of Aluminium Alloys

Environmentally Friendly Product

AXD4000A

New
Products

**Up to 5000 m/min cutting speed.
10000cm³/min metal removal rate is possible.**

(300 km/h = 33000 min⁻¹ x ø50 mm)

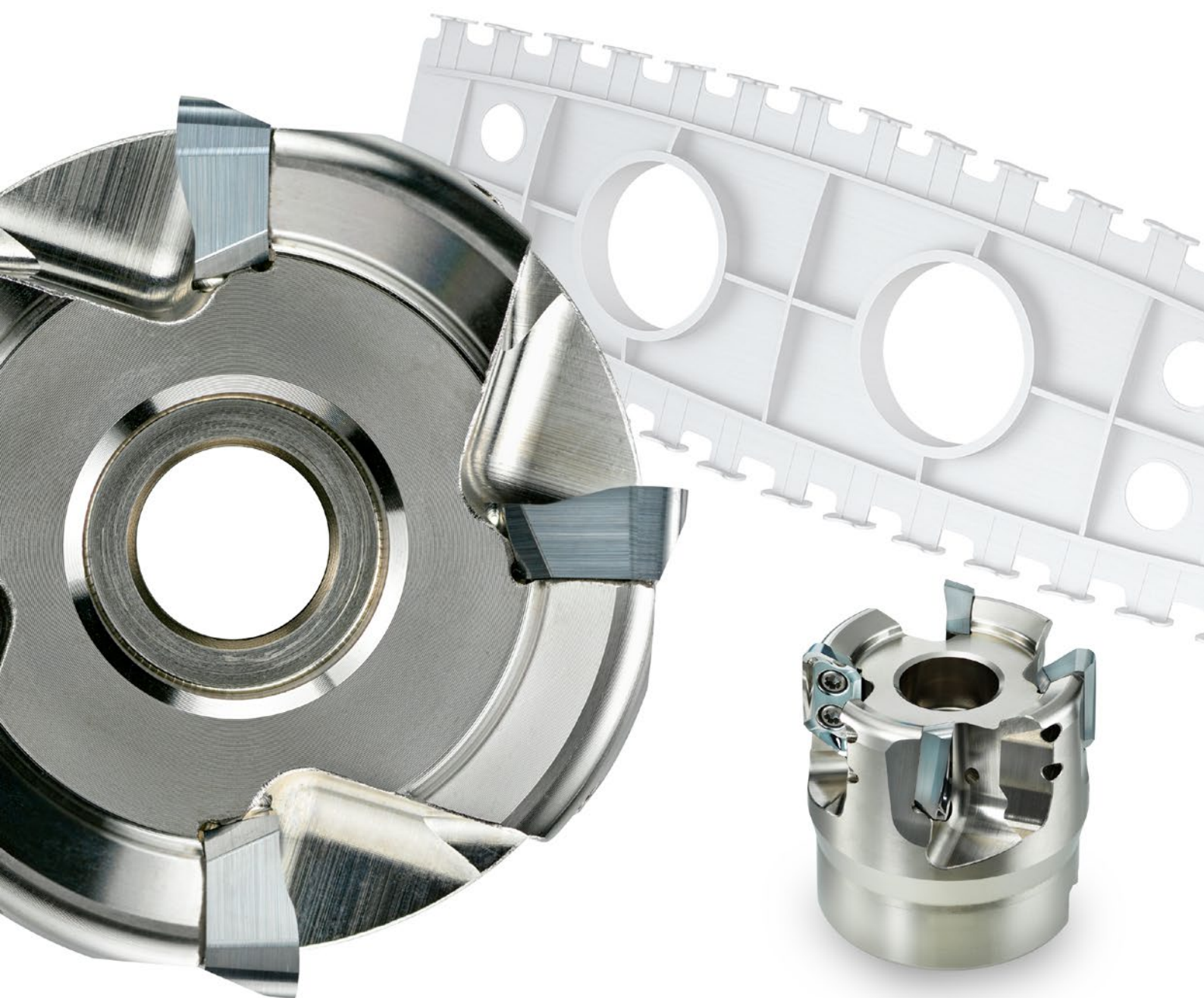

For Ultra-high Speed, Super Efficient Machining of Aluminium Alloys

AXD4000A



Please refer to the last page for more information on certified environmentally friendly products.

High Rigidity Body

The modified insert seat in combination with the rigid body design can withstand the high stresses and centrifugal forces that are exerted during high speed machining.

Optimum Chip Pocket Design

Chip pocket specifically designed for optimal chip disposal during high-speed machining operations.

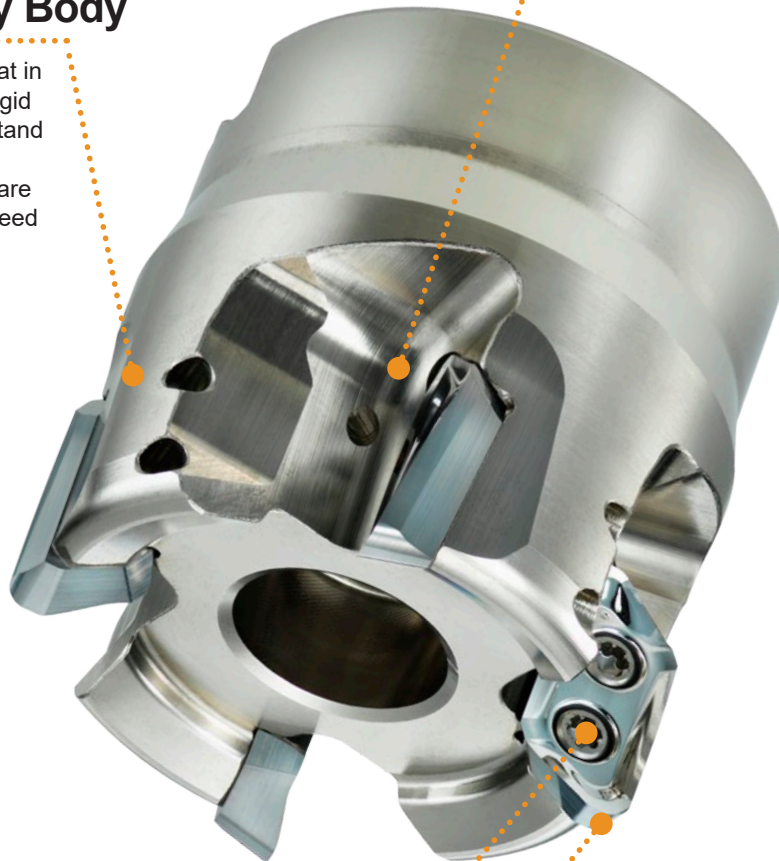

Reliability

Improved anti-fly screws ensure 100% contact with the insert and can be tightened with double the torque specifications compared to the standard AXD4000. The extra torque ensures security of the insert clamping during high speed machining.

Stability

The proven and trusted AXD4000 inserts display a sharp cutting edge with a tough carbide substrate. These features enable lower cutting forces together with substantial resistance to fracturing.

How to Choose AXD4000A or AXD4000

AXD4000A is specifically engineered for continuous high-speed and ultra-high-speed machining of aluminum alloys, and can be better utilised on more powerful machines with more than an 80kW motor.

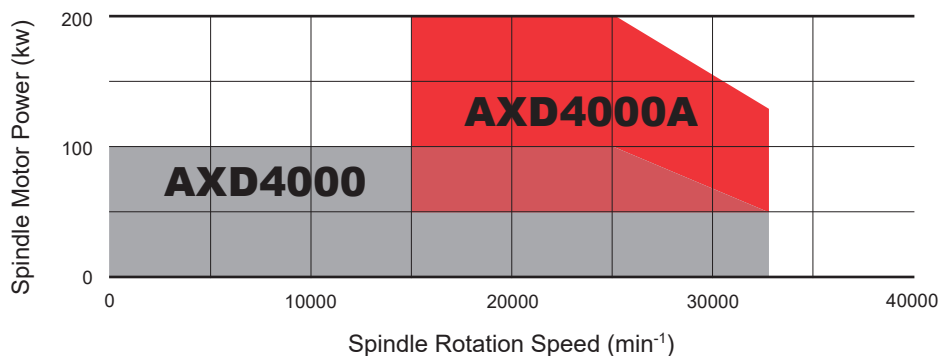

Cemented Carbide Grade for High-speed Processing of Extra Super Duralumin and Aluminium / Lithium alloy

MT2010 NEW

A high grade cemented carbide suitable for ultra-high speed machining at cutting speeds of 5000m/min, combined with excellent wear resistance and toughness.

Cutting Performance

Al-Li Alloy : Comparison of Wear Resistance

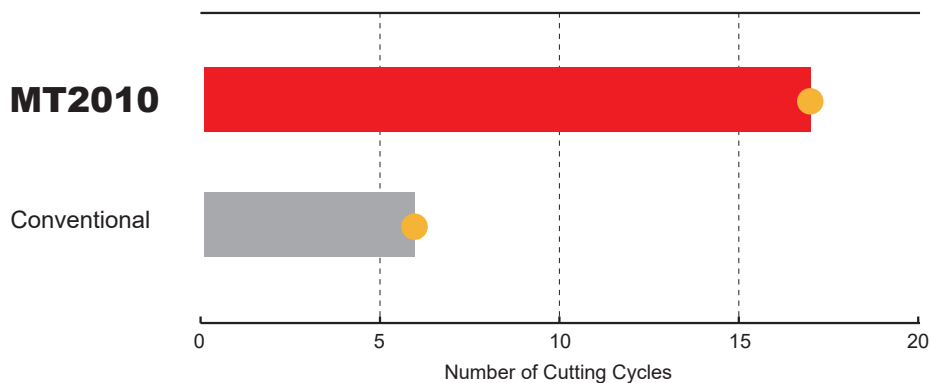

Photographed after 17 machining cycles.



MT2010

Can continue machining.

Photographed after 6 machining cycles.

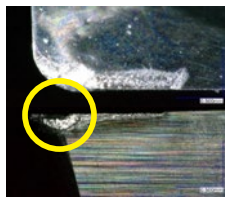

Conventional

Excessive wear created fracturing.

<Cutting Conditions>

Workpiece : Al-Li Alloys
 Material : AXD4000A-050A04RD
 Tool :
 Inserts (Grade): XDGX175004PDFR-GM
 MT2010
 Cutting Speed : $vc=5181$ m/min
 Feed per Tooth : $fz=0.15$ mm/t.
 Depth of Cut : $ap=1.5$ mm
 Width of Cut : $ae=39$ mm
 Cutting Mode : Wet Cutting
 Single Insert

JIS A7050 : Comparison of Fracture Resistance

After machining 90 seconds.



MT2010

Can continue machining.



Conventional

Chipping occurred.

<Cutting Conditions>

Workpiece : JIS A7050
 Material :
 Tool : AXD4000A-050A04RD
 Inserts (Grade): XDGX175004PDFR-GM
 MT2010
 Cutting Speed : $vc=5181$ m/min
 Feed per Tooth : $fz=0.20$ mm/t.
 Depth of Cut : $ap=5.0$ mm
 Width of Cut : $ae=50$ mm
 Cutting Mode : Wet Cutting

For Ultra-high Speed, Super Efficient Machining of Aluminium Alloys

MULTI FUNCTIONAL MILLING

<ALUMINIUM ALLOY MATERIAL CUTTING>



AXD4000A

NEW

- P M K **N** S H



ø50

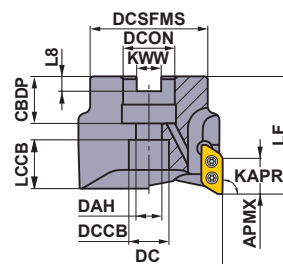

Right hand tool holder only.

(mm)

DC	Set Bolt	Geometry
ø50	HSC10030H	

Arbor Type

KAPR : 90°

GAMP : +10° GAMF : +21°

DCON = inch size, With Coolant Hole

(mm)

DC	Type	Insert Corner Radius RE	Order Number	Stock	* No.T	LF	DCON	WT (kg)	APMX	RPMX (min ⁻¹)	
				R							Insert Type
50	D	0.4—3.2	AXD4000A-050A04RD	●	4	50	22	0.4	15.5	34000	XDGX1750
50	E	4.0—5.0	AXD4000A-050A04RE	●	4	50	22	0.4	14.8	34000	XDGX1750

* Number of Teeth

Note 1) The maximum allowable revolutions are set to ensure tool and insert stability.

RPMX (max. rev/min) for holders must also be considered.

Note 2) Tool should be set with balancing quality of G6.3 (ISO1940) or ISO16084, in case over 6000 min⁻¹ spindle rotation.

Note 3) When using the tool at high spindle speeds, ensure that the tool and chuck are correctly balanced.

Note 4) Note for inserts with a corner radius of 1.6 and above, as corner radius increases the LF dimensions decrease.

Mounting Dimensions

(mm)

DC	Order Number	DCON	CBDP	DAH	DCCB	LCCB	DCSFMS	KWW	L8
50	AXD4000A-050A04RD	22	20	11	17	15.4	45	10.4	6.3
50	AXD4000A-050A04RE	22	20	11	17	14.6	45	10.4	6.3

Spare Parts

	*		
Clamp Screw		Wrench	Anti-seize Lubricant
TPS3SB		TIP10D	MK1KS

* Clamp Torque (N · m) : TPS3SB = 3.0

Note 1) Clamp screw and wrench of AXD4000A are different from AXD4000.

Dimensions and Symbols (ISO 13399 Compliance)

DC = Cutting Diameter

LF = Functional Length

DCON = Connection Diameter

WT = Weight of Item

APMX = Depth of Cut Max.

RPMX = Rotational Speed Max.

CBDP = Connection Bore Depth

DAH = Diameter Access Hole

DCCB = Counterbore Diameter Connection Bore

LCCB = Counterbore Depth Connection Bore

DCSFMS = Contact Surface Diameter Machine Side



KWW = Keyway Width

● : Inventory maintained in Japan.

Memo

A series of horizontal dashed lines for writing, spanning the width of the page.

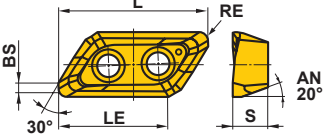









For Ultra-high Speed, Super Efficient Machining of Aluminium Alloys

Inserts											(mm)	
Workpiece Material	N Aluminium Alloys		●		✦		●		✦		Cutting Conditions (Guide): ●:Stable Cutting ●:General Cutting ✦:Unstable Cutting Edge Preparation: F:Sharp E:Round	
	Shape	Order Number	Class	Stock				Dimensions				
Coated				Carbide		L	LE	S	BS	RE*		
Edge Preparation		LC15TF	MP9120	MT2010	TF15							
Strong Cutting Edge GM Breaker 	XDGX175004PDFR-GM	G F			●	●	23.0	17.0	5	1.7	0.4	
	XDGX175008PDFR-GM	G F			●	●	23.0	17.0	5	1.2	0.8	
	XDGX175012PDFR-GM	G F			●	●	23.0	17.0	5	0.9	1.2	
	XDGX175016PDFR-GM	G F			●	●	22.0	15.9	5	1.3	1.6	
	XDGX175020PDFR-GM	G F			●	●	22.0	15.9	5	0.8	2.0	
	XDGX175024PDFR-GM	G F			●	●	22.0	15.9	5	0.4	2.4	
	XDGX175030PDFR-GM	G F			●	●	21.1	16.0	5	0.6	3.0	
	XDGX175032PDFR-GM	G F			●	●	21.1	16.0	5	0.4	3.2	
	XDGX175040PDFR-GM	G F			●	●	20.0	14.8	5	0.5	4.0	
	XDGX175050PDFR-GM	G F			●	●	19.4	15.0	5	0.3	5.0	
Strong Cutting Edge Fracture Resistance Type GM Breaker 	XDGX175004PDER-GM	G E	●				23.0	17.0	5	1.7	0.4	
	XDGX175008PDER-GM	G E	●				23.0	17.0	5	1.2	0.8	
	XDGX175012PDER-GM	G E	●				23.0	17.0	5	0.9	1.2	
	XDGX175016PDER-GM	G E	●				22.0	15.9	5	1.3	1.6	
	XDGX175020PDER-GM	G E	●				22.0	15.9	5	0.8	2.0	
	XDGX175024PDER-GM	G E	●				22.0	15.9	5	0.4	2.4	
	XDGX175030PDER-GM	G E	●				21.1	16.0	5	0.6	3.0	
	XDGX175032PDER-GM	G E	●				21.1	16.0	5	0.4	3.2	
Low Cutting Resistance GL Breaker 	XDGX175004PDFR-GL	G F	●			●	23.0	16.9	5	1.7	0.4	
	XDGX175008PDFR-GL	G F	●			●	23.0	17.0	5	1.3	0.8	
	XDGX175012PDFR-GL	G F	●			●	23.0	17.0	5	0.9	1.2	
	XDGX175016PDFR-GL	G F	●			●	22.0	16.4	5	1.4	1.6	
	XDGX175020PDFR-GL	G F	●			●	22.0	16.4	5	1.0	2.0	
	XDGX175024PDFR-GL	G F	●			●	22.0	16.4	5	0.6	2.4	
	XDGX175030PDFR-GL	G F	●			●	21.1	16.1	5	0.8	3.0	
	XDGX175032PDFR-GL	G F	●			●	21.1	16.1	5	0.6	3.2	
	XDGX175040PDFR-GL	G F	●			●	20.0	15.6	5	0.8	4.0	
	XDGX175050PDFR-GL	G F	●			●	19.4	15.3	5	0.4	5.0	

● = NEW

* The insert nose R differs from radius from the radius formed on the workpiece after machining due to the effects of the axial rake angle at the time of setting.
GM breaker is recommended if the priority is on the dimensional precision of the workpiece corner radius.

Holder And Insert Corner Radius Combination

Holder	D Type Holder								E Type Holder	
	AXD4000A-050A04RD								AXD4000A-050A04RE	
Applicable Insert Corner R (RE)										
	XDGX 175004PD R	XDGX 175008PD R	XDGX 175012PD R	XDGX 175016PD R	XDGX 175020PD R	XDGX 175024PD R	XDGX 175030PD R	XDGX 175032PD R	XDGX 175040PD R	XDGX 175050PD R

Note 1) Other combinations of holder and insert corner R are not acceptable.

● : Inventory maintained in Japan.

Inserts to be used with the AXD4000A ,which include clamping screws, must be ordered via the Kit-order numbers referenced below.

Insert Kit

Package contents of insert kit (10 inserts and 20 clamp screws)

Workpiece Material	N Aluminium Alloys							Cutting Conditions (Guide): ● :Stable Cutting ● :General Cutting ⚡ :Unstable Cutting			
	Shape	Order Number	Stock				Inserts		Clamp Screw		Use
Coated			Carbide		Order Number	Pieces	Order Number	Pieces			
LC15TF			MP9120	MT2010					TF15		
Strong Cutting Edge GM Breaker 	K-XDGX175004PDFR-GM			<input checked="" type="checkbox"/>	<input type="checkbox"/>	XDGX175004PDFR-GM	10	TPS3SB	20	First Recommendation High Speed, High Efficiency and High Load Machining	
	K-XDGX175008PDFR-GM			<input checked="" type="checkbox"/>	<input type="checkbox"/>	XDGX175008PDFR-GM	10	TPS3SB	20		
	K-XDGX175012PDFR-GM			<input checked="" type="checkbox"/>	<input type="checkbox"/>	XDGX175012PDFR-GM	10	TPS3SB	20		
	K-XDGX175016PDFR-GM			<input checked="" type="checkbox"/>	<input type="checkbox"/>	XDGX175016PDFR-GM	10	TPS3SB	20		
	K-XDGX175020PDFR-GM			<input checked="" type="checkbox"/>	<input type="checkbox"/>	XDGX175020PDFR-GM	10	TPS3SB	20		
	K-XDGX175024PDFR-GM			<input checked="" type="checkbox"/>	<input type="checkbox"/>	XDGX175024PDFR-GM	10	TPS3SB	20		
	K-XDGX175030PDFR-GM			<input checked="" type="checkbox"/>	<input type="checkbox"/>	XDGX175030PDFR-GM	10	TPS3SB	20		
	K-XDGX175032PDFR-GM			<input checked="" type="checkbox"/>	<input type="checkbox"/>	XDGX175032PDFR-GM	10	TPS3SB	20		
	K-XDGX175040PDFR-GM			<input checked="" type="checkbox"/>	<input type="checkbox"/>	XDGX175040PDFR-GM	10	TPS3SB	20		
	K-XDGX175050PDFR-GM			<input checked="" type="checkbox"/>	<input type="checkbox"/>	XDGX175050PDFR-GM	10	TPS3SB	20		
Strong Cutting Edge Fracture Resistance Type GM Breaker 	K-XDGX175004PDER-GM	<input type="checkbox"/>				XDGX175004PDER-GM	10	TPS3SB	20	First Recommendation High Speed, High Efficiency and High Load Machining	
	K-XDGX175008PDER-GM	<input type="checkbox"/>				XDGX175008PDER-GM	10	TPS3SB	20		
	K-XDGX175012PDER-GM	<input type="checkbox"/>				XDGX175012PDER-GM	10	TPS3SB	20		
	K-XDGX175016PDER-GM	<input type="checkbox"/>				XDGX175016PDER-GM	10	TPS3SB	20		
	K-XDGX175020PDER-GM	<input type="checkbox"/>				XDGX175020PDER-GM	10	TPS3SB	20		
	K-XDGX175024PDER-GM	<input type="checkbox"/>				XDGX175024PDER-GM	10	TPS3SB	20		
	K-XDGX175030PDER-GM	<input type="checkbox"/>				XDGX175030PDER-GM	10	TPS3SB	20		
	K-XDGX175032PDER-GM	<input type="checkbox"/>				XDGX175032PDER-GM	10	TPS3SB	20		
	K-XDGX175040PDER-GM	<input type="checkbox"/>				XDGX175040PDER-GM	10	TPS3SB	20		
	K-XDGX175050PDER-GM	<input type="checkbox"/>				XDGX175050PDER-GM	10	TPS3SB	20		
Low Cutting Resistance GL Breaker 	K-XDGX175004PDFR-GL	<input type="checkbox"/>			<input type="checkbox"/>	XDGX175004PDFR-GL	10	TPS3SB	20	General Machining	
	K-XDGX175008PDFR-GL	<input type="checkbox"/>			<input type="checkbox"/>	XDGX175008PDFR-GL	10	TPS3SB	20		
	K-XDGX175012PDFR-GL	<input type="checkbox"/>			<input type="checkbox"/>	XDGX175012PDFR-GL	10	TPS3SB	20		
	K-XDGX175016PDFR-GL	<input type="checkbox"/>			<input type="checkbox"/>	XDGX175016PDFR-GL	10	TPS3SB	20		
	K-XDGX175020PDFR-GL	<input type="checkbox"/>			<input type="checkbox"/>	XDGX175020PDFR-GL	10	TPS3SB	20		
	K-XDGX175024PDFR-GL	<input type="checkbox"/>			<input type="checkbox"/>	XDGX175024PDFR-GL	10	TPS3SB	20		
	K-XDGX175030PDFR-GL	<input type="checkbox"/>			<input type="checkbox"/>	XDGX175030PDFR-GL	10	TPS3SB	20		
	K-XDGX175032PDFR-GL	<input type="checkbox"/>			<input type="checkbox"/>	XDGX175032PDFR-GL	10	TPS3SB	20		
	K-XDGX175040PDFR-GL	<input type="checkbox"/>			<input type="checkbox"/>	XDGX175040PDFR-GL	10	TPS3SB	20		
	K-XDGX175050PDFR-GL	<input type="checkbox"/>			<input type="checkbox"/>	XDGX175050PDFR-GL	10	TPS3SB	20		

= **NEW**

For safety reasons, clamping screws must be replaced at the same time as inserts.

Note 1) Use the GM type insert when using with a high-speed, high-power spindle machine for the AXD4000A (spindle RPM of 20000 min⁻¹ or more, motor power of 80 kw or more).

Note 2) The clamp screws and wrenches are different for the AXD4000 and the AXD4000A.

Note 3) For insert dimensions, refer to page 6.

: Non stock, produced to order only.

Please order in the ① insert kit order number and ② insert grades.

Selection of Insert

It is necessary to choose the best insert according to the cutting conditions. Please select an insert from the tables below.
 1st recommendation for efficient, high load machining with a high speed spindle is the GM breaker with a strong cutting edge.

Selection of insert according to the feed per tooth and the required cutting depth

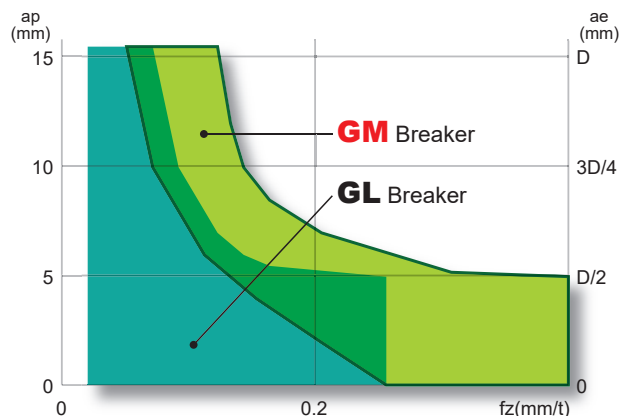

Selection of insert according to the width of cut and the required cutting depth

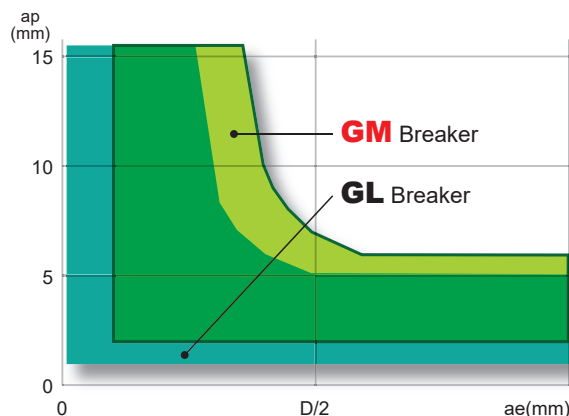

1st recommendation for machining aluminium alloys is GL breaker.
 Under high-load conditions such as deep or high feed cutting, it is advisable to use the GM breaker.

Selection of Insert According to Cutting Edge

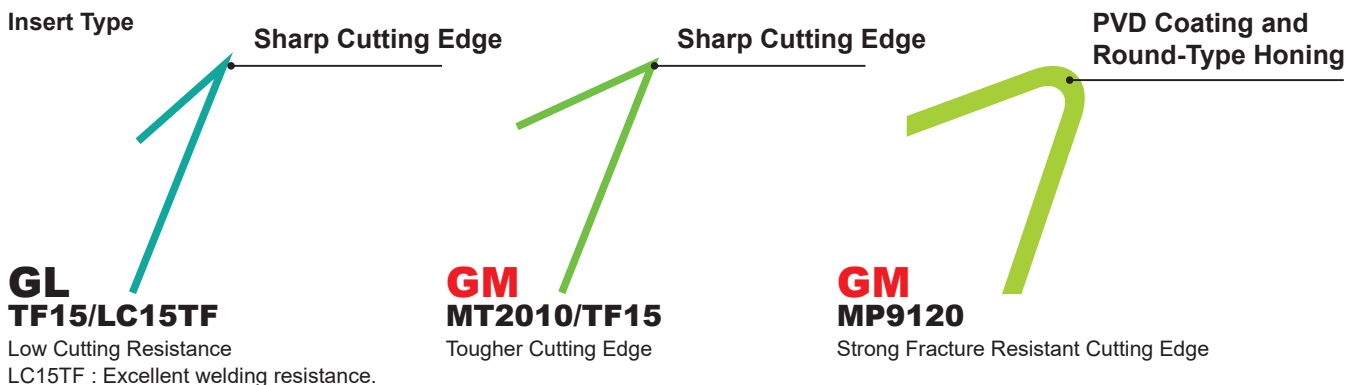

Selection of insert according to wear resistance

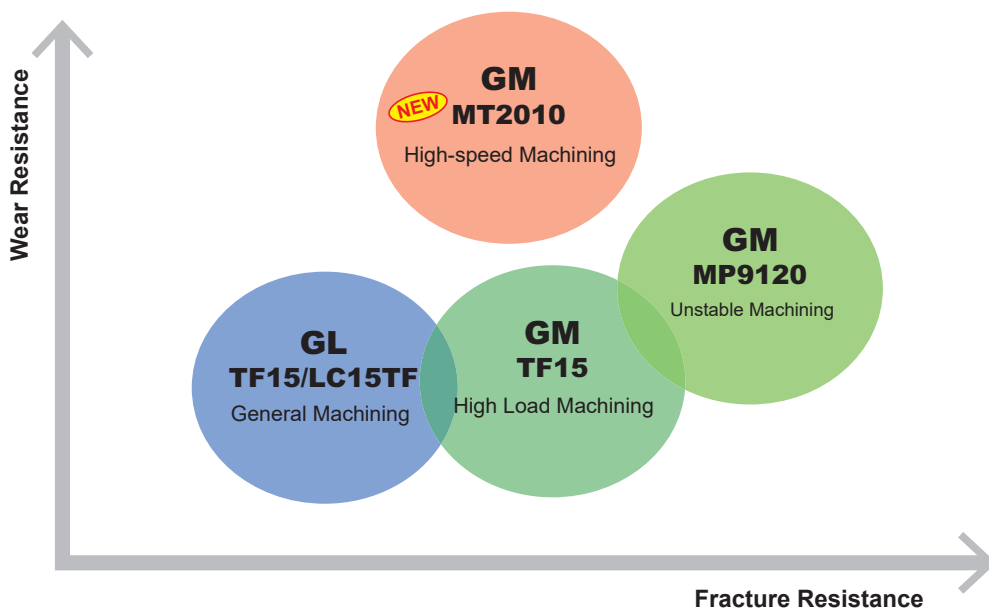

Recommended Cutting Conditions

(mm)

Workpiece Material	Properties	Grade	Breaker	Cutting Speed vc (mm/min)	Cutting Width ae	Depth of Cut ap	Feed per Tooth (mm/t.)
N Aluminium Alloys (A7050, A7075, A2024, A6061 etc) Aluminium-lithium Alloy	Content Si < 5%	MT2010 TF15 MP9120	GM	4000(2000—5000)	≤ 0.5 DC	≤ 5	≤ 0.35
						≤ 10	≤ 0.30
						≤ 14.5	≤ 0.25
		≤ 0.75 DC	≤ 5		≤ 0.30		
			≤ 10		≤ 0.25		
			≤ 14.5		≤ 0.20		
		DC (Slot)	≤ 5	≤ 0.30			
		TF15 LC15TF	GL	4000(2000—5000)	≤ 0.75 DC	≤ 5	≤ 0.20
						≤ 10	≤ 0.15
≤ 14.5	≤ 0.10						
DC (Slot)	≤ 5	≤ 0.20					

Note 1) The above cutting conditions are determined based on high workpiece materials and machine rigidity, where no vibration occurred. If vibrations occur make adjustments according to the machining conditions.

Note 2) Note, vibrations may occur in the following conditions.

- When using a long tool overhang.
- When pocket machining corner radii.
- When the workpiece materials has poor clamping rigidity or when the machine rigidity or workpiece material rigidity is low, vibrations can occur easily, if so, reduce cutting conditions such as width and depth of cut and feed per tooth.

Ramping / Helical Milling / Drilling

Ramping

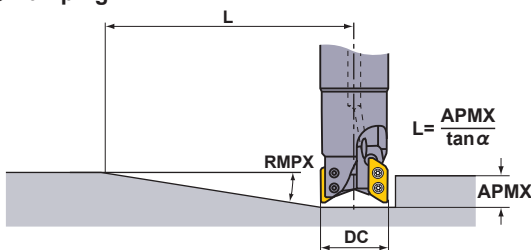

Helical Milling

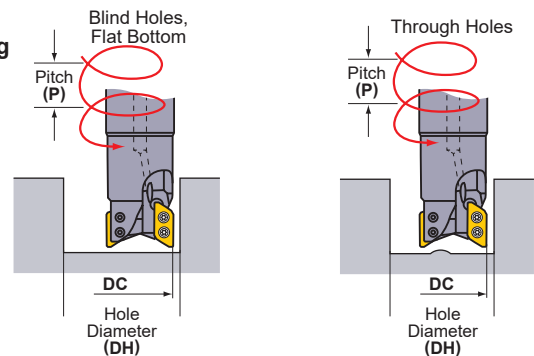

Refer to the table below for cutting conditions. For feed per tooth and cutting speed, follow the cutting conditions for slot milling.

(mm)

DC	Type	Insert Corner R RE	Ramping		Helical Milling (Blind Hole, Flat Bottom)			Helical Milling (Through Hole)		Drilling
			RMPX	L	DH * max.	DH min.	P max.	DH min.	P max.	
50	D	0.4—1.2	8.2°	108	96.8 *2	95.4	14	81.2	14	5.5
		1.6—2.4	7.6°	117	94.4 *3	93.6	13	81.2	13	5.0
		3.0—3.2	6.9°	129	92.8 *4	92.0	12	81.2	12	4.5
	E	4.0	6.3°	135	91.2	90.0	10	81.2	10	3.9
		5.0	5.8°	146	89.2	88.8	9	81.2	9	3.6

*1 Using the maximum ramping angle, the distance to reach the maximum depth of cut is as follows:

L = (maximum depth of cut APMX / tan α). Maximum depth of cut D type is 15.5mm, E type is 14.8mm.

*2 Corner radius of 1.2mm. For other corner radii, use the following formula. {(cutting edge diameter DC) - (corner radius RE) - 0.3} × 2

*3 Corner radius of 2.4mm. For other corner radii, use the following formula. {(cutting edge diameter DC) - (corner radius RE) - 0.3} × 2

*4 Corner radius of 3.2mm. For other corner radii, use the following formula. {(cutting edge diameter DC) - (corner radius RE) - 0.3} × 2

Note 1) The recommended ramping feed is 0.05mm/t. or under.

For Ultra-high Speed, Super Efficient Machining of Aluminium Alloys

Application Examples

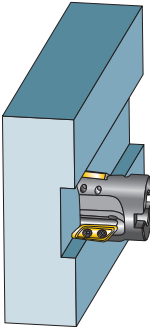
Tool		Conventional		AXD4000A-050A04RD	
Insert (Grade)				XDGX175030PDER-GM(MT2010)	
Workpiece		JIS A7050			
Components		Aircraft Fuselage Parts			
Cutting Conditions	Spindle Speed n (min ⁻¹)	30000		32000	
	Cutting Speed vc (m/min)	4700		5000	
	Feed per Tooth fz (mm/t.)	0.15		0.25	
	Depth of Cut ap (mm)	5		5	
	Width of Cut ae (mm)	50		50	
Metal Removal Rate M.R.R. (cm ³ /min)		4500		8000	
Cutting Mode		Wet Cutting		Wet Cutting	
Machine Spindle Type		High Speed and High Power 5-axis MC			
Result		Metal removal rate was 1.8 times greater than a conventional product. This was made possible by the stability of the AXD4000A cutting action.			

Memo

A series of horizontal dashed lines for writing, spanning the width of the page.



For Ultra-high Speed, Super Efficient Machining of Aluminium Alloys

AXD4000A

Environmentally Friendly Product

This product has been certified as an environmentally friendly product in the machine tool industry by the Japan Cutting & Wear-resistant Tool Association. This is a product unique to the industry, in harmony with the environment, and with the aim of fulfilling the social responsibilities of the machine tool industry.

The Japan Cutting & Wear-resistant Tool Association evaluates the product's environmental impact during the manufacturing and usage stages and issues a certification according to the evaluation score.



AXD4000A Subject : Arbor Type

For People, Society and the Earth

More information about MITSUBISHI MATERIALS' efforts to address social and environmental issues can be found in the website below or by scanning the QR code.

<https://mmc.disclosure.site/en/>



For Your Safety

●Don't handle inserts and chips without gloves. ●Please machine within the recommended application range and exchange expired tools with new ones in advance of breakage. ●Please use safety covers and wear safety glasses. ●When using compounded cutting oils, please take fire precautions. ●When attaching inserts or spare parts, please use only the correct wrench or driver. ●When using rotating tools, please make a trial run to check run-out, vibration and abnormal sounds etc.

MITSUBISHI MATERIALS CORPORATION

MITSUBISHI MATERIALS CORPORATION

Overseas Sales Dept, Asian Region

KFC bldg., 8F, 1-6-1 Yokoami, Sumida-ku, Tokyo 130-0015, Japan
TEL +81-3-5819-8771 FAX +81-3-5819-8774

Overseas Sales Dept, European & American Region

KFC bldg., 8F, 1-6-1 Yokoami, Sumida-ku, Tokyo 130-0015, Japan
TEL +81-3-5819-8772 FAX +81-3-5819-8774

<http://www.mitsubishicarbide.com/en/>
(Tools specifications subject to change without notice.)